

# Instruction manual / Assembly instructions

Please keep!

**Low voltage current transformer  
- split core current transformer -**

**Series XKBR**

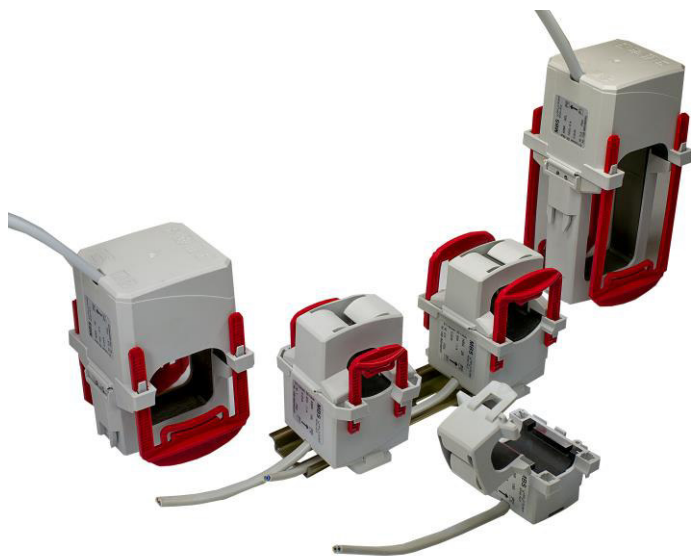

**MBS AG**

**Eisbachstraße 51**

**74429 Sulzbach-Laufen**

**Tel. +49 7976 9851-0**

**Fax. +49 7976 9851-90**

info@mbs-ag.com • www.mbs-ag.com

**Before installing, commissioning or operating the device, please read this manual completely and carefully.**

## 1. Safety instructions



### **Attention**

The following points should be noted:

- The applicable laws, standards and regulations.
- The state of the art at the time of installation.
- The rules of technology.
- The user manual.
- The fact that a manual can only be general and that these instructions must be followed.
- Before commissioning, carefully inspect the device for possible transport damage. In the event of mechanical damage, the device must not be put into operation.
- The devices described are intended for installation by qualified electricians and may only be installed in electrical service rooms or in enclosed enclosures. Any other use or failure to comply with this application notice will void the warranty.
- The devices may only be installed in dry indoor areas.
- Do not install on highly flammable materials.

Operation with a rated current higher than specified on the rating plate can overheat the current transformer

## 2. Function Description

Current transformers of the XKBR series are inductive current transformers. They are used in order to transform the primary measured value into a smaller current which fits with the connected measuring instruments.

Due to the applied measuring principle, these current transformers are suitable for use in AC networks only.

**The XKBR series is only suitable for mounting on insulated primary conductors.**

## 3. Warning notes



### Attention

Dangerous electrical voltage can cause electric shock and burns.

Make sure that the data on the type plate and in the "Technical Data" under **point 7** correspond to the operating parameters of the system.

Switch off the system before starting installation work!



### Attention

In a non-loaded (open) secondary circuit of the current transformer high voltages are induced at the secondary terminals. The occurring voltage values represent a danger to persons as well as the reliability of the current transformer.

**An "open operation", i.e. operation of the current transformer without secondary wiring, is absolutely to be avoided.**

## 4. Installation

- Ensure a safe working environment during installation, maintenance and installation work. Disconnect the power supply of the primary conductor and secure it against unintentional restart.

**Attention:** If during installation the power supply of the primary conductor is not interrupted, the secondary circuit of the current transformer must first be closed. Connect the measuring device or, if necessary, bridge the secondary connections.

- Open the current transformer and fasten it to the primary conductor with the help of the fixing brackets supplied. P1 points to the power source, P2 to the load. The arrow on the rating plate indicates the direction of energy flow.

**Attention:** Do not close the current transformer yet, high voltages can occur at the secondary terminals!

**Attention:** Ensure cleanliness of the cut surfaces of the split core, avoid hand contact (sweat).

- If not already done, connect the secondary cables of the current transformer to the measuring device (ammeter, counter, ..). Refer to its operating instructions.
- Verify that the CT is properly installed and the secondary wires are properly connected.
- Close the current transformer - squeeze until the latch engages.
- If necessary, switch on the power supply of the primary conductor again.

### 4.1. Measuring circuit

Brown conductor: S1

Blue conductor: S2

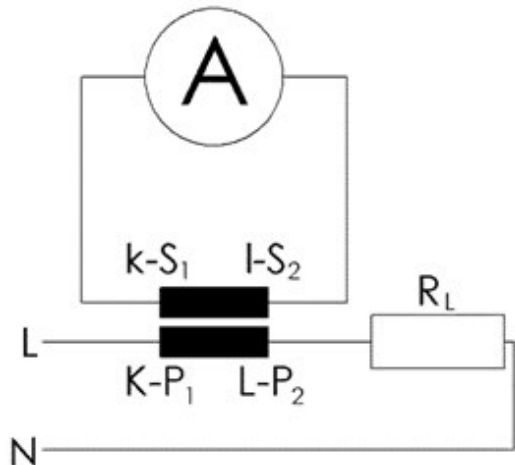

- The types XKBR 18S, XKBR 18L and XKBR 28 can be mounted with optional snap fasteners on a 35 mm DIN top-hat rail (order code see accessories).

## 4.1. Installation instructions



Inserting the fixation braces



Sealing facility for the following types XKBR 18S, XKBR 18L, XKBR 28, XKBR 42 and XKBR 42L

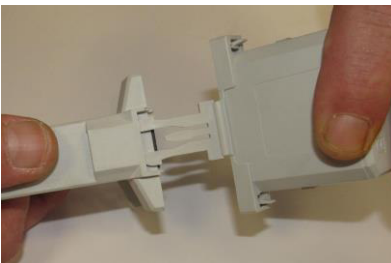

For types XKBR 42 and XKBR 42L, the lower half of the core can be removed for easier assembly.

## 4.2 Notes on measuring the current harmonics

### 4.2.1 Connection cable for current transformer - measuring device

For measurements up to 20 kHz, it should be noted that the connection cable in the standard lengths at 1 A (2.5 m) and at 5 A (0.5 m) was taken into account with regard to the error limits. A special connection cable is not required.

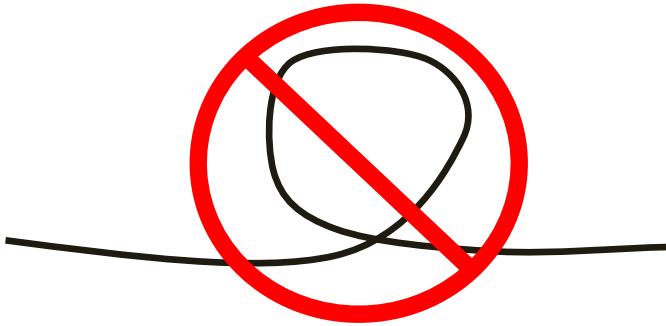

## **. Maintenance and inspection**

- Check whether the secondary cables are firmly connected to the current transformer and to the meter.
- Check if the current transformer is properly closed.
- Remove coarse dirt from the CT housing. Contact with moisture, especially with the core, must be avoided at all costs.

## **6. Troubleshooting**

for example unexpected or wrong values, reverse performance

- Check the settings of the meter according to its operating instructions.
- Check whether the current transformer is mounted on the intended conductor in the energy flow direction.
- Check the power requirements of the cables and measuring instruments connected to the current transformer. This must not exceed the rated power of the current transformer (see type plate).
- Should the aforementioned points not solve the problem: Check for dust or other contamination between the two parts of the core. If so, gently clean the surfaces with a lint-free cloth. Avoid hand contact (sweat)!

## 7. Technical data (for details see rating plate)

### 7.1. General technical data

#### Input sizes

Rated primary current $I_{pr}$ :	see table below 7.2.
Rated continuous thermal current $I_{cth}$ :	1,2 x $I_{pr}$ XKBR 18, 32, 44 1,0 x $I_{pr}$ all other types
Rated short-time thermal current $I_{th}$ :	60 x $I_{pr}$ / 1s
Rated dynamic current $I_{dyn}$ :	2.5 x $I_{th}$
Rated frequency $f_R$ :	50 ... 60 Hz

#### Output sizes

Rated secondary current $I_{sr}$ :	see table under 7.2
Accuracy class (depending on type):	0,5 ... 1
Rated output $S_r$ (depending on type):	0,3 ... 5 VA
Instrument security factor FS (depending on type) :	FS5 up to FS10

#### Operating conditions

Ambient temperature:	-5...+40 °C XKBR 18S -5...+50 °C all other types
Storage temperature:	-25 ... +70 °C
Relative humidity (no condensation):	5 ... 85 %
Altitude:	up to 2000 m

#### Insulation properties

Insulation coordination acc. IEC 61869-1	0,72/3/- kV
Insulation class:	E

#### Remark:

**Only for insulated  
primary conductors**



## Safety

Degree of protection:	IP20
Housing material XKBR 18S, XKBR 18L XKBR 28, XKBR 42, XKBR 42L	PA66 + PA6 UL94-V0
UL-classification of these types:	PA6
Housing material XKBR 18, XKBR 32, XKBR 44:	no
UL-classification for these types:	

## Connection

Feedthrough primary conductor:	see table under 7.2.
Secondary conductors:	see table under 7.2.

<b>In compliance with:</b>	IEC 61869-1 IEC 61869-2
----------------------------	----------------------------

The latest edition of the mentioned documents applies, including all changes.

## Accessories

Snap fastening for  
DIN rail



XKBR 18S  
XKBR 18L, XKBR 28

Order-no. 55016  
Order-no. 55017

## 7.2. Technical data type related

	XKBR 18S	XKBR 18	XKBR 18L	XKBR 28	XKBR 32	XKBR 42	XKBR 42L	XKBR 44
Rated primary current [A]	60..250	50..250	100..250	200..500	100..600	250..1000	250..1000	250..1000
Secondary rated current [A]	1	1	1 or 5	1 or 5	1 or 5	1 or 5	1 or 5	1 or 5
Fitting for primary conductor-Ø max. [mm]	18,5	18,5	18,4	27,9	32,5	42,4	42,4	44,0
Width [mm]	36,0	41,6	49,0	49,0	59,2	67,0	67,0	72,2
Hight [mm]	51,1	64,5	68,8	68,2	96,4	96,0	139,0	120,6
Secondary conductor 1A <sub>1)</sub>	2,5 m 0,5 mm <sup>2</sup>	2,5 m 0,75 mm <sup>2</sup>	2,5 m 0,5 mm <sup>2</sup>	2,5 m 0,5 mm <sup>2</sup>	2,5 m 0,75 mm <sup>2</sup>	2,5 m 0,5 mm <sup>2</sup>	2,5 m 0,5 mm <sup>2</sup>	2,5 m 0,75 mm <sup>2</sup>
Secondary conductor 5A <sub>1)</sub>	---	---	0,5 m 1,5 mm <sup>2</sup>	0,5 m 1,5 mm <sup>2</sup>	0,5 m 1,5 mm <sup>2</sup>	0,5 m 1,5 mm <sup>2</sup>	0,5 m 1,5 mm <sup>2</sup>	0,5 m 1,5 mm <sup>2</sup>

- 1) standard length,  
other lengths available on request

### 7.3. Identification of the rating plate

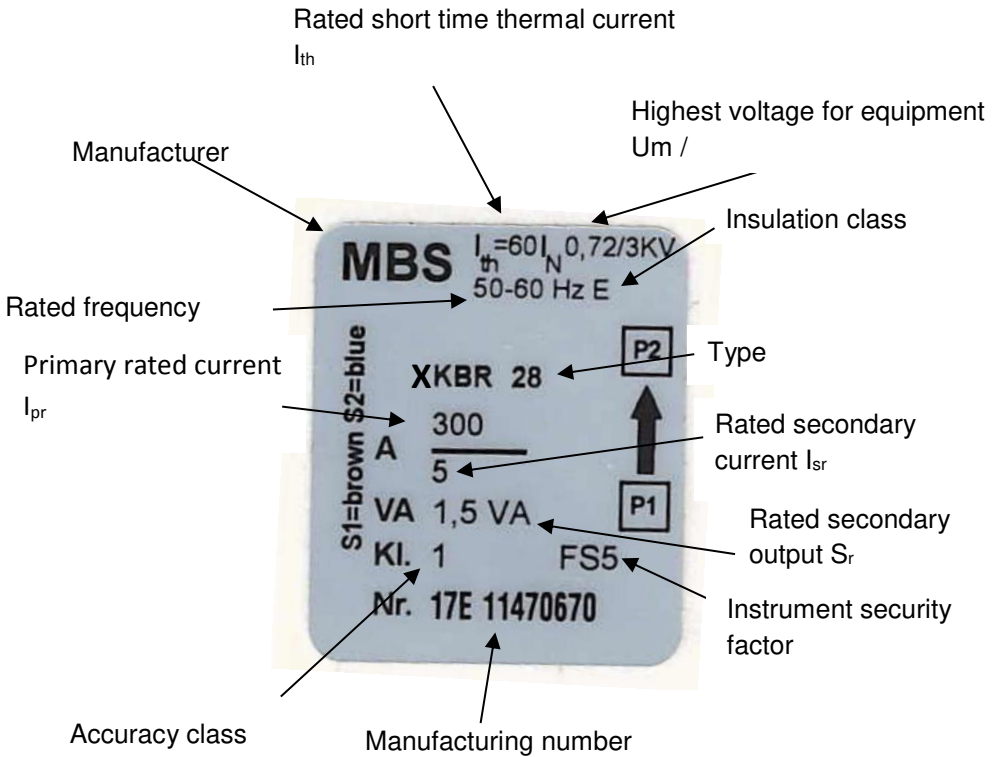

## 7.4. Second rating plate regarding frequency

permissible load for the guaranteed accuracy class - the rated power  $S_r$  can be found on the rating plate

**Attention:** The measuring instruments must represent a purely resistive load.

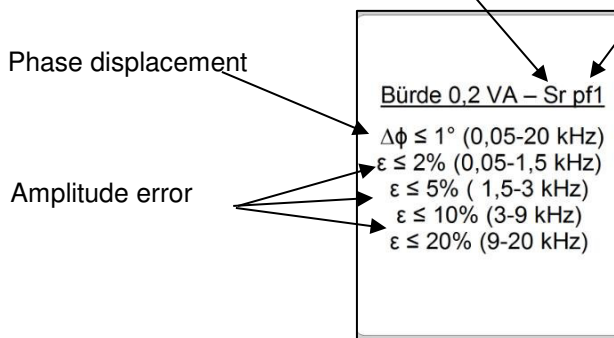

**Attention:** The instrument security factor  $FS$  only applies to the nominal load  $S_r$  on the main rating plate under 7.3.

## 8. Product information

MBS AG has been developing, producing and selling current and voltage transformers for more than 40 years. Our customers trust in the worldwide known quality of our products.

The production of MBS AG includes current transformers with closed and split cores. These undergo several tests during the production process to ensure the quality standards of MBS AG.

The split design of the XKBR product group means that these current transformers are more sensitive to external influences than current transformers with a closed core.

In addition to environmental conditions such as temperature and humidity, as well as mechanical stress, other factors such as contamination, corrosion and damage to the cut surfaces can affect the accuracy of the ct.

MBS AG as the manufacturer has no influence on these factors. However, there is a continuous development of the products to minimize the impact.

Any deviations in the measuring accuracy caused by these influences, especially in the long-term measuring behavior, can not be completely ruled out.

However, the total error occurring as a consequence of the above-mentioned influences is generally always within permissible error tolerances under operational conditions.

(The permissible error tolerances are at most twice the standard error value.)

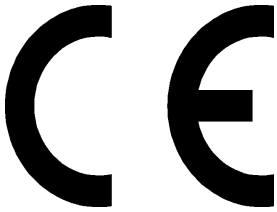

This product was made in compliance with the applicable standards (IEC 61869-1/-2) and meets the requirements of the

Low Voltage Directive 2014/35 / EU.



MBS AG hereby declares that its products use only components from qualified manufacturers whose specifications meet or exceed the requirements of the EU directive on the restriction of the use of certain hazardous substances.

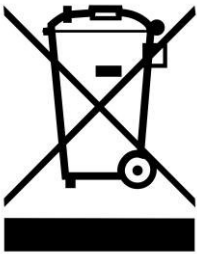

When the product reaches the end of its life, it must be recycled. Do not discard with household waste!

If necessary, ask a waste consultant!



**MBS AG**

Eisbachstrasse 51 • 74429 Sulzbach-Laufen • Germany

Telefon: +49 7976 9851-0 • Telefax: +49 7976 9851-90

info@mbs-ag.com • www.mbs-ag.com