

LEONI DC Solutions



The Quality Connection

LEONI



We connect technology, efficiency & ecological awareness already today.

BETAflam® Clean cables for clean energy.

Whether it is an off-grid application or a grid connected PV-System – our cables meet the same high expectations that are demanded from the solar modules – **which are a long service life and high weather resistance.**

Our double insulated, electron-beam cross-linked cables meets the highest requirements for solar cables in the most important photovoltaic markets of Europe and the USA and can be used unrestrictedly as a module or connecting cable.

Our products have both TÜV approval for the European market and UL approval acc. to the latest NEC specifications (National Electric Code 2008 / UL Outline 4703).



Issue: May 2019 © LEONI Studer AG

The contents of this brochure are protected by copyright. All rights reserved.

We reserve the right to make technical modifications, typographical errors and mistakes.

The current version of the catalogue is downloadable under www.leoni-wind-solar-power.com

Safety instructions

Cables are to be used for the designated applications only. In case of failure or damage to the cable or connector, switch off power immediately and replace all damaged parts. Maintenance, repair and replacement of the cables and connectors may only be carried out by authorised and trained personnel.

Waiver

While the information contained in this document has been carefully compiled to the best of our knowledge, it is not intended as a representation or warranty of any kind on our part regarding the suitability of the products concerned for any particular use or purpose and neither shall any statement contained herein be construed as a recommendation to infringe any industrial property rights or as a license to use any such rights. The suitability of each product for any particular purpose must be checked beforehand with our specialists. Our policy is one of continuous material and product development. We reserve the right to offer alternatives consistent with our manufacturing programme at the time of enquiry. All information concerning material properties, Fire performance, construction, electrical and technical data, prices etc. reflects our current level of knowledge and is provided without obligation. Dimensions and weights are only given as a guide. The specifications may change any time without prior notice.

General conditions of sale and delivery

We refer to the currently valid General conditions of sale and delivery which can be obtained from the respective companies.

Some of the terms used in this document are not used consistently in the industry. LEONI, however, endeavours to use terminology consistently in the interests of transparent business relationships and customer communication. In order to avoid difficulties in their interpretation, we refer you to the definitions of the terms used by us available at www.leoni.com/en/company/copper-business/

The current version at the time this document was sent is the binding version. These definitions form part of the contract. If the terms defined there are used in this document, they have the meaning given there. We will be pleased to provide you with a list of these definitions if required.

	page
Profile – Energy & Infrastructure	4
Nature is brilliant. Cleanly efficient.	5
Green Technology	6
The LEONI PV system	8
All products at a glance	10

BETAflam® LEONI DC cables & accessories

BETAflam® Solar 125 flex UL/EN	12
BETAflam® Solar 125 S flex UL/EN	13
BETAflam® Solar 125 flex 1500 V DC	14
BETAflam® Solar 125 RV flex 1500 V DC	15
SOLARpower Outdoor Alu XS	NEW 16
SOLARpower Alu-ATA XS	NEW 17
SOLARpower Alu-ATA Terminal and grounding kit	18
SOLARpower Brace for screw cable lugs	18
TRAFO-FLEX flexible	NEW 20
BETAflam® Solar L-02YSC2Y 2X2X0.5/2.1-120 BK	22
BETAflam® Solar LI02YSC2Y 4X2X0.5/2.0-120 BK	23

System solutions

iC/DC Cabling harnessing system & solution for PV power plants	24
iC/DC Cabling product portfolio	25
DC solutions by LEONI and Weidmüller	26

Technical information 27

Max. current rating for BETAflam® Solar & Alu-ATA cables	28
Standard packaging / Transport conditions	29
Smoke density	30
Flame retardance	30
Halogen-freeness	31
Degree of acidity of combustion gases	31
Electron-beam cross-linking	32

LEONI – the all-in-one service provider	34
LEONI DC Solutions – Approved and certified quality	35
Our sales network	36

Profile – Energy & Infrastructure

Passion for an innovative, intelligent and sustainable energy supply

In the course of global networking, urbanization and the growing world population, innovative solutions are needed. Sustainability, effectiveness and intelligent systems will be the main challenge of the future, both in the use of renewable energies and in the optimization of existing plants. LEONI is already meeting this demands today. Innovative quality products and intelligent project-comprehensive services provide the connections of the future.

Environmentally friendly technologies and sustainable products are the challenges to be met facing worldwide market trends like globalisation, industrialisation and automation, ecological awareness and scarcity of resources, mobility, urbanisation and demographic change. These trends play a particularly significant part in the fields of energy and infrastructure. From the energy generation process to energy distribution all the way to the energy customer – we are everywhere where highest reliability, quality and durability matter.

Thus we offer complete solutions for requirements in the areas:

- **Transport routes and building infrastructure**
- **Large-scale projects**
- **Energy generation and distribution**
- **Solar and wind technology**

Our inspiration

Major projects such as the Gotthard and Ceneri base tunnels, various international metro projects or the Linth-Limmern hydropower plant benefit not only from the comprehensive range, but also from the extensive project management we achieve with Building Technologies from planning to acceptance. In doing so, our products and projects solutions meet all standards and help determine those of tomorrow.

We connect the world with sustainable, secure and intelligent energy and data transmission solutions.

That's our passion.

The LEONI group

LEONI is a global provider of products, solutions and services for energy and data management in the automotive sector and other industries. The value chain encompasses wires, optical fibers, standardised cables, special cables and assembled systems as well as intelligent products and smart services. As an innovation partner and solutions provider, LEONI supports its customers with pronounced development and systems expertise. The market-listed group of companies employs more than 92,000 people in 31 countries and generated consolidated sales of EUR 5.1 billion in 2018.

Further informations www.leoni.com

Nature is brilliant. Cleanly efficient.

Solar- & Windpower



Trusting the only true constant – nature – makes sense and is the safest way in the long term.

Solar and wind energy are the energy sources of the future. The basic elements sun and air are natural forces that shape our climate. Using their limitless power sustainably and cleanly for the energy consumption of mankind is the great challenge facing the energy supply of the near future.

Achieving maximum efficiency is the responsibility of leading technology development companies. Innovative strength, creativity, inspiration and the courage to forge new paths are the requirements for tomorrow's clean energy world.

LEONI Solar & Windpower is aware of this task and already combines technology, innovation and ecological awareness today. Environmentally compatible manufacture for environmentally compatible energy production through renewable energy. That is our motto.

Whether it is for local production, manufacturer or grid operator, we offer our customers products, systems and project management support in line with the market.

Our worldwide presence allows us to react flexibly, quickly and competently to our customers' requirements in the most important solar and wind markets. Ambitious large projects like solar heat, solar parks and wind farms are based on more than just the development of renewable energy resources, they also involve ecological and energy awareness. Utilising nature thus also means being consistent in the long run.

For further information www.leoni-energy-infrastructure.com

Green technology

Our company aim is to combine innovation with sustainability.



Our vision is to create sustainable connections in technological harmony with the natural resources. The cycle of nature gives us the best model to emulate. It is our responsibility to learn from nature and make use of it while conserving it and treating it with care. The growing scarcity of the natural resources and the increasing burden on the environment require a rethink on all levels of society. For LEONI, sustainability is an integral part of group policy. We are the first cable manufacturer in the world to develop a holistic concept for “green technology”.

While trends like globalisation, mobility and urbanisation also determine the markets, sustainability and global responsibility are a central credo. To be considered an innovative cable manufacturer for environmentally friendly technologies – that is our goal. At that, it is of vital interest to us to detect the needs and requirements of tomorrow today and supply the markets of the future with sustainable, future-proof solutions.

Green technology stands for the resource-conserving and low-emission production of sustainable quality cables made with low-pollution elements. We constantly work at optimising the efficiency with which resources are used in the manufacturing process by deploying energy-efficient machines or taking heat

recovery measures. More and more locations in our global production network are environmentally certified acc. to the ISO 14001 standard.

As a worldwide active and leading European supplier of wires, optical fibres, cables and cable systems for communication and infrastructure projects it is our responsibility to constantly optimise the sustainability and durability of our products, system solutions and services and thus lower the environmental load. We have to increase the amount of environmentally compatible raw materials in our cable products as well as the recyclability of processed materials or components and in doing so create end products that are developed for the environmental standard of tomorrow today.

In conjunction with the ecological compatibility, future technologies are measured in terms of efficiency, service life, emission reduction and the conservation of natural resources. Innovative cable products and systems, holistic solutions and maximum performance in project management are the added value which we offer to our customers and business partners. These are also our cornerstones for strong connections into the future.



REACH >

There are various environmental directives in the European Union (EU).

Directive 2012/19/EU WEEE (Waste Electrical and Electronic Equipment) regulates the disposal of electrical and electronic equipment and components.

The use of certain hazardous materials in electrical and electronic devices is defined by Directive 2011/65/EU RoHS 2 (Restriction of Hazardous Substances). Chemicals and materials in general are regulated by the law on chemical substances 1907/2006/EC REACH (Registration, Evaluation, Authorisation and Restriction of Chemicals).



REACH

This means avoiding the following substances, among others:

- Polybrominated diphenyl ether (PBDE)
- Decabromodiphenyl ether (DecaBDE)
- Perfluorooctane sulfonate (PFOS)
- Pentabromodiphenyl ether (PentaBDE)
- Octabromodiphenyl ether (OctaBDE)
- Lead (Pb)
- Mercury (Hg)
- Cadmium (Cd)
- Hexavalent chromium (Cr VI)
- Polybrominated biphenyls (PBB)



Cables and conductors and their associated connectors are only affected by Directive 2012/19/EU WEEE insofar as they are an internal part of the listed equipment and components.

Cables and conductors have now been included in 2011/65/EU RoHS 2 since 2013 for the first time (Category 11 or as an internal component of the respective product). Fiber optic cables, power cables (>250 V) and installed fixed cables e.g. in premises are not concerned. The only permissible marking acc. to RoHS 2 is the CE marking, which is printed on the product package.

→ EU Directive 2012/19/EU on waste electrical and electronic equipment.

→ EU Directive 2011/65/EU for restriction of the use of certain hazardous substances in electrical and electronic equipment.

→ EU Regulation 1907/2006/EC (REACH) the chemical regulation of the European Union.

What does REACH mean?

REACH stands for Registration, Evaluation, Authorisation and Restriction of Chemicals.

With REACH, the previous chemical law is basically harmonised, simplified and valid in all EU Member States.

Under REACH, there is a so-called candidate list with substance of very high concern (SVHC), which are subject to obligatory information and should be substituted in the long run. The list of candidate materials is updated twice per year by the European Chemicals Agency (ECHA) in Helsinki.

The LEONI PV system

Overview of our complete range of products

BETAflam® Solar 125 flex 1500 V DC	page 14
BETAflam® Solar 125 RV flex 1500 V DC	page 15
SOLARpower Outdoor Alu XS	page 16
SOLARpower Alu-ATA XS	page 17
Terminal and grounding kit	page 18
BETAflam® Solar L-02YSC2Y 2X2X0.5/2.1-120 BK	page 21
BETAflam® Solar LI02YSC2Y 4X2X0.5/2.0-120 BK	page 22

Combiner Box

page 26

BETAflam® Solar **125 flex UL/EN** **page 12**

BETAflam® Solar **125 S flex UL/EN** **page 13**

BETAflam® Solar **125 flex 1500 V DC** **page 14**

BETAflam® Solar **125 flex 1500 V DC** **page 14**

BETAflam® Solar **125 RV flex 1500 V DC** **page 15**

All products at a glance

DC cables

✓ Photovoltaic module cables

- BETAflam® Solar 125 flex UL/EN
➤ page 12



- BETAflam® Solar 125 S flex UL/EN
➤ page 13



- BETAflam® Solar 125 flex 1500 V DC
➤ page 14



- BETAflam® Solar 125 RV flex 1500V DC
➤ page 15



✓ Photovoltaic installation cables ✓ Battery storage ✓ E-mobility ✓ Public transport

- SOLARpower Outdoor Alu XS
➤ page 16



- SOLARpower Alu-ATA XS
➤ page 17



- SOLARpower Alu-ATA accessories
Terminal and grounding kit
➤ page 18



- TRAF0-FLEX flexible
➤ page 20



✓ Photovoltaic installation cables

- BETAflam® Solar
L-02YSC2Y 2X2X0.5/2.1-120 BK
➤ page 21



- BETAflam® Solar
LI02YSC2Y 4X2X0.5/2.0-120 BK
➤ page 22



Combiner boxes

- DC-Solutions by LEONI and Weidmüller
 > page 26



CPR fire classification



The CPR fire performance classification is mandatory for all cables used as construction product and under the scope of hEN 50575 from 1 July 2017 onwards. The safety levels are as follows:

CPR Fire class	Safety level	Application
B2 _{ca} s1d0a1	Very high fire safety, very low smoke, halogen free	Hospitals, tunnels, public transport
C _{ca} s1d1a1	High fire safety, very low smoke, halogen free	(airports, railway stations, metros), ...
D _{ca} s2d2a2	Medium fire safety, low smoke, halogen free	Typical standard building application
E _{ca}	Low fire safety	Typically PVC, Polychloroprene, ...
F _{ca}	No fire safety	Typical outdoor cable

For further information about the Construction Products Regulation (CPR) please visit www.leoni.com/en/cpr

BETAflam® Solar 125 flex UL/EN

Photovoltaic power cables, halogen free, flame retardant



• BAUART
GEPRÜFT
• TYPE
APPROVED

EN50618
certified



LISTED
PV wire
USE-2

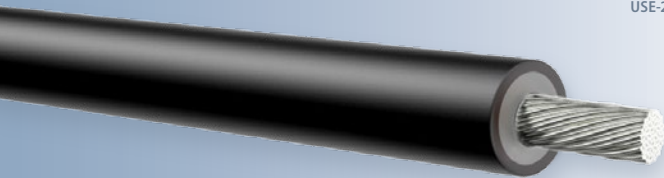

Advantages

- EN50618 & UL 2000V approval
- Electron-beam cross-linked compounds
- UV, ozone and hydrolysis resistant
- High temperature resistance, the materials do not melt or flow
- Very long service life*, good cold flexibility
- Compatible to all popular connectors
- Improved encapsulation properties

BETAflam® Solar 125 flex UL/EN

Applications

- Double insulated, electron-beam cross-linked cables for photovoltaic power applications.

Construction

- Conductor Tinned fine copper strands acc. to VDE 0295 / IEC 60228, Class 5
- Insulation XLPO, flame retardant, halogen free, electron-beam cross-linked
- Jacket XLPO, flame retardant, halogen free, electron-beam cross-linked, UV and ozone resistant
- Jacket colour ● black

Electrical characteristics

Rated value	U₀ 1500 VDC / EN50618 (max. permitted voltage U ₀ 1800 VDC) UL 2000 V
-------------	---

Thermal characteristics

Operating temperature	-40 °C up to +120 °C -40 °F up to +248 °F
Ambient temperature	-40 °C up to +90 °C
min. 25 years**	-40 °F up to +194 °F
Max. short circuit temp.	+280 °C, +536 °F / 5 s

Bending radius

Fixed installation	> 4 × Ø
Occasionally moved	> 5 × Ø

Standards / Material properties

- Fire performance IEC 60332-1; UL 1581 1060 / VW1
- Smoke emission IEC 61034; EN 61034-2
- Low fire load DIN 51900
- Approvals EN50618; H1Z2Z2-K, UL4703 PV wire, cTÜVus
- Application standards NEC 2008 / UL PV wire; EN 50618, IEC 62930

Nominal cross section	Conductor Ø	Outer Ø	Resistance max. at 20°C	Weight	Fire load	Order no.
n × mm ²	mm	mm	mΩ/m	kg/km	kWh/m	
1 × 2.5 14 AWG	1.95	6.85	8.21	67	0.187	310810
1 × 4 12 AWG	2.45	7.05	5.09	86	0.213	310811
1 × 6 10 AWG	3.00	7.60	3.39	109	0.238	310812
1 × 10 8 AWG	3.90	9.70	1.95	155	0.340	310813
1 × 16 6 AWG	5.00	10.80	1.24	224	0.605	312296
1 × 25 4 AWG	6.20	12.00	0.79	310	0.704	312297
1 × 35 2 AWG	7.70	13.50	0.56	418	0.871	312298
1 × 50 1 AWG	9.70	16.80	0.39	617	1.347	312299

Nominal cross section	Order no.
n × mm ²	8 × 1000 m 1 × 5000 m
1 × 2.5 14 AWG	* 310810V4
1 × 4 12 AWG	310811V3 310811V4
1 × 6 10 AWG	* *
1 × 10 8 AWG	* *

* on request.

More information on the standard packaging unit see page 34.
Further packaging units on request. **Bold** printed order no. = stock item

** Subject to the standard IEC 60216 -1 (Thermal endurance properties – Ageing procedures and evaluation of test results) and the test conditions specified in the EN50618 – 2014 (Electric cables for photovoltaic systems), a cable material should pass a test with specific test conditions described therein. The standard IEC60216 -1 further states that these test conditions simulate a lifetime of min. 25 years. LEONI warrants that the cables would successfully pass this test before the delivery to the customer.

BETAflam® Solar 125 S flex UL/EN

Photovoltaic power cables, halogen free, flame retardant



EN50618
certified



LISTED
PV wire
USE-2



Advantages

- UL 4703 PV wire, EN50618
- Electron-beam cross-linked compounds
- UV, ozone and hydrolysis resistant
- High temperature resistance, the materials do not melt or flow
- Very long service life*, good cold flexibility
- Compatible to all popular connectors
- Improved encapsulation properties

BETAflam® Solar 125 S flex UL/EN

Applications

- Double insulated, electron-beam cross-linked cables for photovoltaic power applications.

Construction

- Conductor Tinned fine copper strands acc. to VDE 0295 / IEC 60228, Class 5
- Insulation XLPO, flame retardant, halogen free, electron-beam cross-linked
- Jacket XLPO, flame retardant, halogen free, electron-beam cross-linked, UV and ozone resistant
- Jacket colour ● black

Electrical characteristics

Rated value **U₀ 1500 V DC / EN50618**
(max. permitted voltage U₀ 1800 V DC)
UL 2000 V

Thermal characteristics

Operating temperature -40 °C up to +120 °C
-40 °F up to +248 °F
Ambient temperature -40 °C up to +90 °C
min. 25 years** -40 °F up to +194 °F
Max. short circuit temp. +280 °C, +536 °F / 5 s

Bending radius

Fixed installation > 4 × Ø
Occasionally moved > 5 × Ø

Standards / Material properties

- Fire performance IEC 60332-1; UL 1581 2556 / FV1
- Smoke emission IEC 61034; EN 61034-2
- Low fire load DIN 51900
- Approval UL 4703 PV wire, EN50618; H1Z2Z2-K
- Application standards NEC 2008 / UL PV wire; EN 50618, IEC 62930

Nominal cross section	Conductor Ø	Outer Ø	Resistance max. at 20°C	Weight	Fire load	Order no.
n × mm ²	mm	mm	mΩ/m	kg/km	kWh/m	
1 × 2.5 14 AWG	1.95	6.4	8.21	63	0.192	313504
1 × 4 12 AWG	2.45	6.4	5.09	69	0.260	313505

Nominal cross section	Order no.
n × mm ²	8 × 1000 m 1 × 5000 m
1 × 2.5 14 AWG	* 313504V4
1 × 4 12 AWG	310811V3 313505V4

* on request.

More information on the standard packaging unit see page 34.
Further packaging units on request.

Bold printed order no. = stock item

** Subject to the standard IEC 60216 -1 (Thermal endurance properties – Ageing procedures and evaluation of test results) and the test conditions specified in the EN50618 . 2014 (Electric cables for photovoltaic systems), a cable material should pass a test with specific test conditions described therein. The standard IEC60216 -1 further states that these test conditions simulate a lifetime of min. 25 years. LEONI warrants that the cables would successfully pass this test before the delivery to the customer.

BETAflam® Solar 125 flex 1500V DC

Photovoltaic power cables, halogen free, flame retardant

CPR

D_{ca}

CCHDA0000020



• BAUART
GEPRÜFT
• TYPE
APPROVED

EN50618
certified

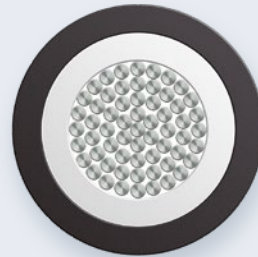

Advantages

- EN50618 approval
- Electron-beam cross-linked compounds
- UV, ozone and hydrolysis resistant
- High temperature resistance, the materials do not melt or flow
- Good cold flexibility
- Very long service life >25 years at 90 °C
- Compatible to all popular connectors

BETAflam® Solar 125 flex 1500V DC

Applications

Is used as photovoltaic cable between solar modules and inverters in a photovoltaic system with a rated value $U_0 = 1.5$ kV DC.

Construction

- Conductor Tinned fine copper strand acc. to VDE 0295 / IEC 60228, Class 5
- Insulation XLPO, flame-retardant, halogen free, electron-beam cross-linked
- Jacket XLPO, flame-retardant, halogen free, electron-beam cross-linked, UV and ozone resistant, **with white or red marking and stripe**
- Jacket colour ● black

Electrical characteristics

Rated value	$U_0 = 1500$ V DC (max. permitted voltage U_0 1800 V DC)
Test voltage	6.5 kV AC 50 Hz

Thermal characteristics

Operating temperature	-50 °C up to +120 °C
Ambient temperature	-50 °C up to +90 °C
Max. short circuit temp.	+280 °C, +536 °F / 5 s

Bending radius

Fixed installation	$> 4 \times \varnothing$
Occasionally moved	$> 5 \times \varnothing$

Standards / Material properties

- Fire performance IEC 60332-1; IEC/EN 60332-3-25
- Smoke emission IEC 61034; EN 61034-2
- Low fire load DIN 51900
- Approvals EN50618; H1Z2Z2-K

Fire properties acc. to CPR

- D_{ca}-s2, d2, a2 EN 50575, EN 13501-6
- Fire performance D_{ca} EN 50399
- Low corr. of the combustion gases EN 60754-2
– halogen free a2
- Medium smoke density s2 EN 50399
- Flaming droplets d2 EN 50399
- No flame propagation EN 60332-1-2
- Material selection RoHS-compliant

Nominal cross section	Conductor \varnothing	Outer \varnothing	Resistance max. at 20°C	Weight	Fire load	Order no.	
						○ White*	● Red*
$n \times mm^2$	mm	mm	m Ω /m	kg/km	kWh/m	○ White*	● Red*
1 × 4	2.45	6.15	5.09	71	0.143	309345	309349
1 × 6	3.00	6.70	3.39	92	0.161	309346	309350
1 × 10	3.90	7.70	1.95	136	0.191	309347	309351

* Jacket colour black with red or white inscription

Nominal cross section	Order no.							
	40 × 100 m		50 × 100 m		18 × 500 m		8 × 1000 m	
$n \times mm^2$	○ White*	● Red*	○ White*	● Red*	○ White*	● Red*	○ White*	● Red*
1 × 4	–	–	309345V8	309349V8	309345V2	309349V2	309345V3	309349V3
1 × 6	309346V8	309350V8	–	–	309346V2	309350V2	309346V3	309350V3

More information on the standard packaging unit see page 34. Further packaging units on request.

* Jacket colour black with red or white inscription

You can download the corresponding declaration of performance from our website www.leoni.com/en/cpr by entering the declaration of performance ID.

BETAflam® Solar 125 RV flex 1500V DC

Photovoltaic power cables, halogen free, flame retardant

Advantages

- EN50618 approval
- Electron-beam cross-linked compounds
- UV, ozone and hydrolysis resistant
- High temperature resistance, the materials do not melt or flow
- Good cold flexibility
- Very long service life >25 years at 90 °C
- Compatible to all popular connectors

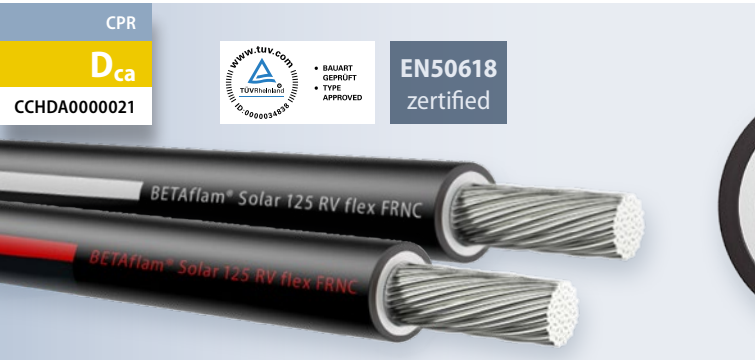

BETAflam® Solar 125 RV flex 1500V DC

Applications

Is used as photovoltaic cable between solar modules and inverters in a photovoltaic system with a rated value $U_0 = 1.5$ kV DC.

Construction

- Conductor Tinned fine copper strand acc. to VDE 0295 / IEC 60228, Class 5
- Insulation XLPO, flame-retardant, halogen free, electron-beam cross-linked
- Jacket XLPO, flame-retardant, halogen free, electron-beam cross-linked, UV and ozone resistant, **with white or red marking and stripe**
- Jacket colour ● black

Electrical characteristics

Rated value $U_0 = 1500$ V DC
(max. permitted voltage U_0 1800 V DC)

Test voltage 6.5 kV AC 50 Hz

Thermal characteristics

Operating temperature -50 °C up to $+120$ °C
Ambient temperature -50 °C up to $+90$ °C
Max. short circuit temp. $+280$ °C, $+536$ °F / 5 s

Bending radius

Fixed installation $> 4 \times \varnothing$
Occasionally moved $> 5 \times \varnothing$

Standards / Material properties

- Fire performance IEC 60332-1
- Smoke emission IEC 61034; EN 61034-2
- Low fire load DIN 51900
- Approvals EN50618; H1Z2Z2-K, IEC 62930

Fire properties acc. to CPR

- D_{ca} -s2, d2, a2 EN 50575, EN 13501-6
- Fire performance D_{ca} EN 50399
- Low corr. of the combustion gases EN 60754-2
– halogen free a2
- Medium smoke density s2 EN 50399
- Flaming droplets d2 EN 50399
- No flame propagation EN 60332-1-2
- Material selection RoHS-compliant

Nominal cross section	Conductor \varnothing	Outer \varnothing	Resistance max. at 20°C	Weight	Fire load	Order no.	
$n \times mm^2$	mm	mm	m Ω /m	kg/km	kWh/m	○ White*	● Red*
1 × 2.5	1.95	5.00	8.21	46	0.095	313738	313739
1 × 4	2.45	5.50	5.09	61	0.109	313740	313741
1 × 6	3.00	6.10	3.39	82	0.127	313742	313743
1 × 10	3.90	7.20	1.95	126	0.158	313744	313745
1 × 16	5.00	8.50	1.24	190	0.213	313746	–
1 × 25	6.20	10.40	0.79	291	0.314	313747	–
1 × 35	7.70	11.90	0.56	400	0.392	313748	–
1 × 50	9.70	14.30	0.39	570	0.549	313749	–

* Jacket colour black with red or white inscription

Nominal cross section	Order no.					
	8 × 500 m		18 × 500 m		8 × 1000 m	
$n \times mm^2$	○ White*	● Red*	○ White*	● Red*	○ White*	● Red*
1 × 4	–	–	313740V2	313741V2	313740V3	313741V3
1 × 6	–	–	313742V2	313743V2	313742V3	313743V3
1 × 10	313744V3	–	–	–	–	–

More information on the standard packaging unit see page 34. Further packaging units on request. **Bold** printed order no. = stock item * Jacket colour black with red or white inscription

You can download the corresponding declaration of performance from our website www.leoni.com/en/cpr by entering the declaration of performance ID.

SOLARpower Outdoor Alu XS

Low voltage cable, halogen free

NEW

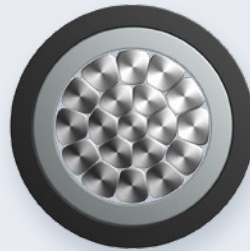
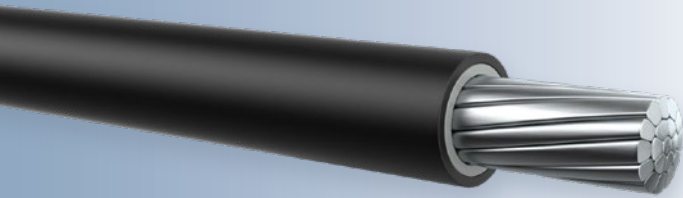

Advantages

- Acc. to TÜV Rheinland 2PFG2642/11.17
- For protected installation in ground
- Termite protection as option
- Halogen-free
- XLPE Insulation and jacket
- UV resistant
- Simple feed, low friction of the jacket

SOLARpower Outdoor Alu XS

Applications

Halogen free. UV resistant low voltage cable. Especially well suited for outdoor applications due to the very robust outer sheath. Acc. to TÜV Rheinland 2PFG2642/11.17 for aluminium cables and protected, fixed installation in ground.

Construction

- Conductor Aluminium stranded wire, compacted. class 2
- Insulation XLPE, halogen free
- Jacket XLPE, halogen-free

- Jacket colour ● black

Electrical characteristics

Max. voltage	$U_m = 1800 \text{ V DC}$
Rated voltage	$U_0/U = 1500 \text{ V} / 1500 \text{ V DC}$ $U_0/U = 1000 \text{ V} / 1000 \text{ V AC}, 50 \text{ Hz}$
Test voltage	6500 V, 50 Hz, 5 min.

Thermal characteristics

Operating temperature	-40 °C up to +90 °C -40 °F up to +194 °F
Ambient temperature	-40 °C up to +90 °C
Min. permissible installation temperature	-10 °C
Max. short circuit temp.	+250 °C, +482 °F / 5 s

Bending radius

Fixed installation	$> 12 \times \varnothing$
--------------------	---------------------------

Standards / Material properties

- Halogen free IEC 60754-1; EN 50267-2-1
- Approval TÜV 2PFG2642/11.17 approved

>> For termination, we recommend screw cable lugs for aluminium conductor (see page 18).

Nominal cross section	Conductor- \varnothing	Outer- \varnothing	Resistance max.	Voltage drop	Weight	Order no.
$n \times \text{mm}^2$	mm	mm	m Ω /m	mV/Am	kg/km	
1×50	8.2	13.2	0.641	1.282	207	315694
1×70	9.9	14.9	0.443	0.886	275	315695
1×95	11.4	16.8	0.320	0.640	364	315696
1×120	12.9	18.3	0.253	0.506	451	315697
1×150	14.0	19.8	0.206	0.412	530	315698
1×185	16.4	23.0	0.164	0.328	682	315699
1×240	18.0	25.0	0.125	0.250	856	315700
1×300	20.5	27.9	0.100	0.200	1057	315701
1×400	23.7	31.9	0.0778	0.1556	1376	315702
1×500	26.4	34.6	0.0605	0.121	1688	315703
1×630	30.1	38.9	0.0469	0.0938	2130	316120

SOLARpower Alu-ATA XS

Low voltage cable, halogen free

NEW

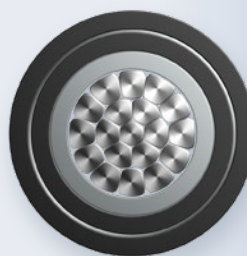

Advantages

- Acc. to TÜV Rheinland 2PFG2642/11.17
- For direct burial
- Radial humidity resistant
- Halogen-free
- XLPE Insulation and termigon jacket
- Termite and rodent protection
- UV resistant
- Simple feed, low friction of the jacket
- Aluminium shield, suitable as grounding and protective earth and for EMC shielding

SOLARpower Alu-ATA XS

Applications

Halogen free. UV resistant low voltage cable. Especially well suited for outdoor applications and burial directly in the ground. Due to the very robust outer sheath and the aluminium tube as humidity barrier. Aluminium tube can be used as ground wire. TÜV Rheinland 2PFG2642/11.17 approved.

Construction

- Conductor Aluminium stranded wire, compacted. class 2
- Insulation XLPE, halogen free
- Armouring Aluminium tube / extra hard compound
- Jacket Copolymer, halogen free
termite and rodent protection
- Jacket colour ● black

Electrical characteristics

Max. voltage	$U_m = 1800 \text{ V DC}$
Rated voltage	$U_0/U = 1500 \text{ V} / 1500 \text{ V DC}$ $U_0/U = 1000 \text{ V} / 1000 \text{ V AC}, 50\text{Hz}$
Test voltage	6500 V, 50 Hz, 5 min. (Conductor / Shielding)

Thermal characteristics

Operating temperature	-40 °C up to +90 °C -40 °F up to +194 °F
Ambient temperature	-40 °C up to +90 °C
Min. permissible installation temperature	-10 °C
Max. short circuit temp.	+250 °C, +482 °F / 5 s

Bending radius

Fixed installation	$> 12 \times \varnothing$
--------------------	---------------------------

Standards / Material properties

- Halogen free IEC 60754-1; EN 50267-2-1
- Approval TÜV 2PFG2642/11.17 approved

>> For termination and shield grounding, we recommend our SOLARpower Alu-ATA terminal and grounding kit (see page 18).

Nominal cross section	Conductor- \varnothing	Outer- \varnothing	Resistance max.	Voltage drop	Weight	Order no.
$n \times \text{mm}^2$	mm	mm	m Ω /m	mV/Am	kg/km	
1 × 50/18	8.2	17.1	0.641	1.282	317	315684
1 × 70/20	9.9	18.8	0.443	0.886	398	315685
1 × 95/22	11.4	20.9	0.32	0.64	510	315686
1 × 120/24	12.9	22.4	0.253	0.506	603	315687
1 × 150/26	14.0	24.1	0.206	0.412	732	315688
1 × 185/30	16.4	27.7	0.164	0.328	896	315689
1 × 240/31	18.0	29.9	0.125	0.25	1091	315690
1 × 300/36	20.5	33.0	0.100	0.200	1336	315691
1 × 400/39	23.7	37.4	0.0778	0.1556	1725	315692
1 × 500/43	26.4	40.1	0.0605	0.121	2044	315693
1 × 630/48	30.1	44.8	0.0469	0.0938	2553	316121

SOLARpower Alu-ATA

Accessories

Advantages

- Includes all materials for the installation
- Reliable and harmonized connection and grounding concept
- With accurate use, acc. to the instruction manual, no contact corrosion due to durable sealing
- Consistently safe contact with the aluminium conductor and the earthing screen
- Grounding wire in tinned copper braid with water blocking

centering sleeves

roll springs



cover caps

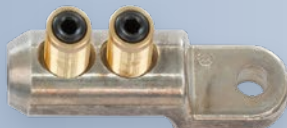

screw cable lug



heat-shrink tube



2 × sealing strip



assembled grounding wire with water blocking

SOLARpower Alu-ATA Terminal and grounding kit

Applications

The set includes all materials which are required for a safe, permanent connection and a proper grounding.

Content

- Instruction manual
- Screw cable lug M12 with 13 mm hole
- Assembled grounding wire 0.5 m
- 2 × sealing strip 152 mm
- Roll springs
- Heat-shrink tube MDT-A, black colour

SOLARpower Brace for screw cable lugs



Article	Order no.
SOLARpower Brace for screw cable lugs with outer diameter 14–30 mm	315528

Article	Order no.
SOLARpower Alu-ATA 50–95 Terminal and grounding kit	310767
SOLARpower Alu-ATA 95–240 Terminal and grounding kit	310768
SOLARpower Alu-ATA 300 Terminal and grounding kit	310769



Terminal and grounding kit fully assembled

Instruction manual
 > scan the QR code or
 click [here](#) for the download



TRAFO-FLEX flexible

BETAflam® low-voltage power cable

NEW

CPR

D_{ca}

CCHDA0000006

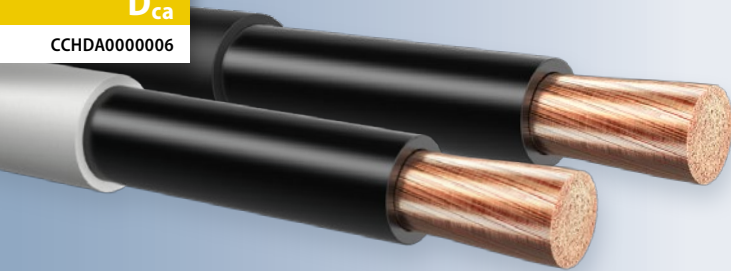

Advantages

- Halogen-free and flame-retardant
- Compact strand structure suitable for standard or DIN cable lugs
- Cross-linked EPR insulation
- UV resistant

BETAflam® TRAFO-FLEX

Applications

Fixed or flexible installation with light mechanical stress in dry, damp and wet rooms. The special strand construction allows easy connection with standard or DIN cable lugs. Safe electrical connection thanks to the ethylene-propylene rubber insulation.

Structure

- Conductor Copper strand, bare, fine-wire, cert. to VDE 60288/IEC 60228, class 5
- Insulation Ethylene propylene rubber (EPR), cross-linked
- Sheath PE-based plastic, grey (UV resistant black optional available)

Electrical properties

Nominal voltage	U/U ₀	600/1000 V (with fixed installation)
Test voltage		3500 V with 50 Hz/5 minutes

Thermal characteristics

Continuous operation	+90 °C
Emergency operation	+130 °C (< 8 h/d; < 100 h/a)
Short-circuit temperature	+250 °C (max. 5 s)

Bending radius

Cable pull	> 8 × outer Ø
Installation	> 6 × outer Ø

Pull on the conductor

Max. 60 N/mm ²	(1 × conductor cross-section × 60 N/mm ²)
---------------------------	--

Standards / Material properties

- Structure cert. to VDE 60288/IEC 60228, Class 5
- Halogen-free IEC 60754-1, EN 50267-2-1
- No corrosive gases IEC 60754-2, EN 50267-2-2
- No toxic gases NES 02-713
- Flame retardant IEC 60332-1

Special features





- LEONI also offers a range of accessories for connection and fixing systems.
- Versions with improved fire resistance properties and other cross-sections on request.

Cable structure	Core function	Strand structure	Strand Ø	Outside Ø	Weight	Bending radius cable pull ¹ / Installation ²	Tractive force ³	Order no.
n × mm ²		n × mm Ø	mm	mm	kg/100 m	mm	max. kN	
1 × 95	L	437 × 0.5	13.2	20.6	105	165/124	5.7	221227
1 × 95	PE/PEN	437 × 0.5	13.2	20.6	105	165/124	5.7	221891
1 × 120	L	570 × 0.5	15.0	22.8	134	182/137	7.2	221532
1 × 120	PE/PEN	570 × 0.5	15.0	22.8	134	182/137	7.2	221894
1 × 150	L	702 × 0.5	17.4	25.6	164	205/154	9.0	221029
1 × 150	PE/PEN	702 × 0.5	17.4	25.6	164	205/154	9.0	221896
1 × 185	L	864 × 0.5	18.9	27.9	197	223/167	11.1	221239
1 × 185	PE/PEN	864 × 0.5	18.9	27.9	197	223/167	11.1	221897
1 × 240	L	1147 × 0.5	21.4	31.0	255	248/186	14.4	221030
1 × 240	PE/PEN	1147 × 0.5	21.4	31.0	255	248/186	14.4	221210
1 × 300	L	1406 × 0.5	23.5	33.7	312	270/202	18.0	221533
1 × 300	PE/PEN	1406 × 0.5	23.5	33.7	312	270/202	18.0	302287
1 × 400	L	1488 × 0.5	27.5	39.1	430	313/235	24.0	221976

- ¹ Calculation method for cable pull: ≥ 8 × outside Ø
- ² Calculation method for installation: ≥ 6 × outside Ø
- ³ Calculation method for max. tractive force: 60 N/mm² on conductor

You can download the corresponding declaration of performance from our website www.leoni.com/en/cpr by entering the declaration of performance ID

Current carrying capacity

Cable structure	Installation in conduit in the ground ⁴ 			Installation in conduit in the ground ⁵ 		
	Continuous load ¹ /industrial load ²		Emergency operation ³	Continuous load ¹ /industrial load ²		Emergency operation ³
n × mm ²	60 °C A	90 °C A	130 °C A	60 °C A	90 °C A	130 °C A
1 × 95	200/235	252/296	298	244/287	307/361	363
1 × 120	231/272	292/343	345	281/331	354/417	419
1 × 150	265/312	334/393	396	321/378	405/477	479
1 × 185	297/349	374/441	443	359/423	453/533	536
1 × 240	347/409	439/516	520	420/495	530/624	628
1 × 300	393/462	496/584	589	476/560	600/706	711
1 × 400	458/539	580/682	689	557/655	703/827	833
	Installation in air 			Installation in air 		
1 × 95	236	342	440	277	400	513
1 × 120	278	404	519	326	472	605
1 × 150	325	473	608	383	553	709
1 × 185	370	537	690	435	628	804
1 × 240	441	641	825	520	751	962
1 × 300	506	736	948	599	865	1107
1 × 400	606	882	1138	722	1042	1334

- ¹ Load level over 24 h, 100% nominal current (use primarily for power generating systems)
- ² Load level over 10 h, 100% and 14 h, 60% nominal current (standard use)
- ³ Maximum for 8 h per day and max. 100 h per year
- ⁴ Pipe inner diameter min. 3 × single conductor outer diameter
- ⁵ Pipe inner diameter min. 1.5 × cable diameter

Calculation method:
Installation depth 1 m, ground temperature 20 °C, air temperature 30 °C, bilateral shield earthing, specific thermal resistance of the ground 1 Km/W, protected against direct solar radiation, one cable system installed individually.

BETAflam® Solar L-02YSC2Y 2X2X0.5/2.1-120 BK

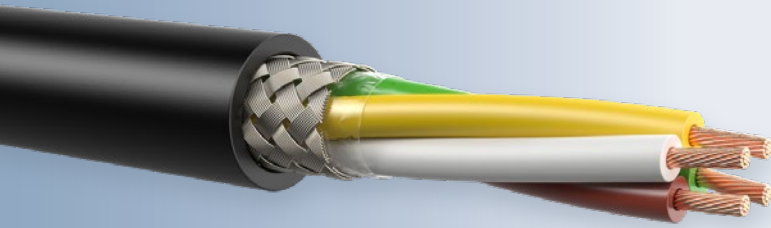

Advantages

- Especially for PV applications
- UV resistant
- Low capacitance
- Suitable for long distances and direct burial

BETAflam® Solar L-02YSC2Y 2X2X0.5/2.1-120 BK

Applications

UV resistant data cable for direct burial. Special designed for PV applications.

Construction

- Conductor Stranded bare copper wire (20 AWG) \varnothing 0.95 mm (0,037 in dia.)
- Insulation Polyethylene (PE) with skin \varnothing 2.1 mm (0,083 in dia.)
- Core 4 wires twisted, sequence of colors: WH-BN-GN-YE, plastic tape, overlapped,
- Shielding braiding of tinned copper wires, coverage about 80% \varnothing 5.8 mm (0.228 in)
- Jacket Polyethylene (PE) BK, \varnothing (8.1 \pm 0.4) mm (0.319 \pm 0.016 in)
- Jacket colour ● black

Electrical data at 20°C

Conductor resistance	$\leq 36 \Omega/\text{km}$
Insulation resistance	$\geq 5 \text{ G}\Omega^* \text{ km}$
Capacitance (1 kHz)	$\approx 35 \text{ nF/km}$
Characteristic impedance ($\geq 1 \text{ MHz}$)	(120 \pm 20) Ω
rel. velocity of propagation	$\approx 80 \%$
Operating voltage (peak)	$\leq 300 \text{ V}$
Test voltage (wire / wire / screen rms 50 Hz 1min)	2000 V

Mechanical and thermal characteristics

Conductor material	acc. to DIN EN 13602 Cu-ETP-A ...
Screen material	acc. to DIN EN 13602 Cu-ETP-A ...-B
Insulating material	acc. to DIN EN 50290-2-23 (VDE 0819), table 2/A (HD 624.3) (02Y)
Jacket material	acc. to DIN EN 50290-2-24 (VDE 0819), table 1/2-L/MD (HD 624.4)

Attenuation

Frequency (MHz)	0.1	1	5	10	20
Attenuation typ. (dB/100m)	0.4	1.3	3.9	5.8	8.2
Attenuation typ. (dB/100ft)	(0.1)	(0.4)	(1.2)	(1.8)	(2.5)

Other characteristics

- Cable for direct burial
- RoHS compliant (Directive 2011/65/EC)
- Sunlight resistant acc. to UL 444 Sec. 7.12

Permissible temp. range

Transport and fixed instal. $-40 \text{ }^\circ\text{C}$ ($-40 \text{ }^\circ\text{F}$) up to $80 \text{ }^\circ\text{C}$ ($176 \text{ }^\circ\text{F}$)

Instal. and flexible use $-30 \text{ }^\circ\text{C}$ ($-22 \text{ }^\circ\text{F}$) up to $80 \text{ }^\circ\text{C}$ ($176 \text{ }^\circ\text{F}$)

Min. bending radius repeated $8 \times \varnothing$, single $4 \times \varnothing$

Weight about 56 kg/km ($37,5 \text{ lb/1000ft}$)

Packaging

- 500 m (1640 ft) on non-returnable reel

BETAflam® Solar LI02YSC2Y 4X2X0.5/2.0-120 BK

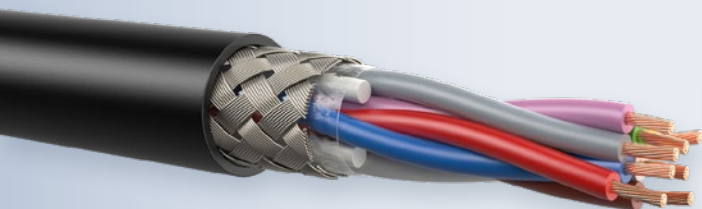

Advantages

- Especially for PV applications
- UV resistant
- Low capacitance
- Suitable for long distances and direct burial

BETAflam® Solar LI02YSC2Y 4X2X0.5/2.0-120 BK

Applications

UV resistant data cable for direct burial. Special designed for PV applications.

Construction

- Conductor Stranded bare copper wire (20 AWG) \varnothing 0.95 mm (0,037 in dia.)
- Insulation Polyethylene (PE) with skin \varnothing 2.0 mm (0,079 in dia.), 2 wires twisted to a pair
- Core 4 pairs twisted to a core with fillers in the gaps. Plastic tape overlapped.
- Shielding braiding of tinned copper wires, coverage about 80 %
- Jacket Polyethylene (PE) BK, \varnothing (10.5 \pm 0.4) mm (0.413 \pm 0.016 in dia.)
- Jacket colour ● black

Electrical data at 20°C

Conductor resistance	$\leq 36 \Omega/\text{km}$
Insulation resistance	$\geq 5 \text{ G } \Omega^* \text{ km}$
Capacitance (1 kHz)	$\approx 40 \text{ nF/km}$
Characteristic impedance ($\geq 1 \text{ MHz}$)	(120 \pm 20) Ω
rel. velocity of propagation	$\approx 80 \%$
Operating voltage (peak)	$\leq 300 \text{ V}$
Test voltage (wire / wire / screen rms 50 Hz 1min)	2000 V

Mechanical and thermal characteristics

Conductor material	acc. to DIN EN 13602 Cu-ETP-A ...
Screen material	acc. to DIN EN 13602 Cu-ETP-A ...-B
Insulating material	acc. to DIN EN 50290-2-23 (VDE 0819), table 2/A (HD 624.3) (02Y)
Jacket material	acc. to DIN EN 50290-2-24 (VDE 0819), table 1/2-L/MD (HD 624.4)

Attenuation

Frequency (MHz)	0.1	1	5	10	20
Attenuation typ. (dB/100m)	0.45	1.1	2.8	3.9	5.7
Attenuation typ. (dB/100ft)	(0.1)	(0.3)	(0.9)	(1.2)	(1.7)

Other characteristics

- Cable for direct burial
- RoHS compliant (Directive 2011/65/EC)
- Sunlight resistant acc. to UL 444 Sec. 7.12

Permissible temp. range

Fixed installation	$-40 \text{ }^\circ\text{C}$ ($-40 \text{ }^\circ\text{F}$) up to $80 \text{ }^\circ\text{C}$ (176 $^\circ\text{F}$)
Occasionally moved	$-30 \text{ }^\circ\text{C}$ ($-22 \text{ }^\circ\text{F}$) up to $80 \text{ }^\circ\text{C}$ (176 $^\circ\text{F}$)
Min. bending radius	repeated $8 \times \varnothing$, single $4 \times \varnothing$
Weight about	100 kg/km (67,0 lb/1000ft)

Packaging

- 500 m (1640 ft) on non-returnable reel

iC/DC Cabling harnessing system & solution for PV power plants

inter Connectivity for DC cabling

iC/DC Cabling stands for innovation and quality.

Our customized Plug & Play harnessing solutions maintain PV BoS (Balance of System) according customers request for combiner/re-combiner boxes, junction boxes, PV wire, in-line fuses, racking and string level monitoring solutions.

Our Service support provides the highest standards for excellence and our engineers pursuit for technology innovation, that drives LEONI to invent intelligent solutions.

LEONI's patented iC/DC Cabling harnessing System simplify the PV installation and making the integration of solar panels a breeze. Plug & Play with customized or standard pre-terminated PV installation cable reduce your Opex and Capex and increase your System Quality yield, a real gain of the LCoE (Levelized Cost of Electricity).

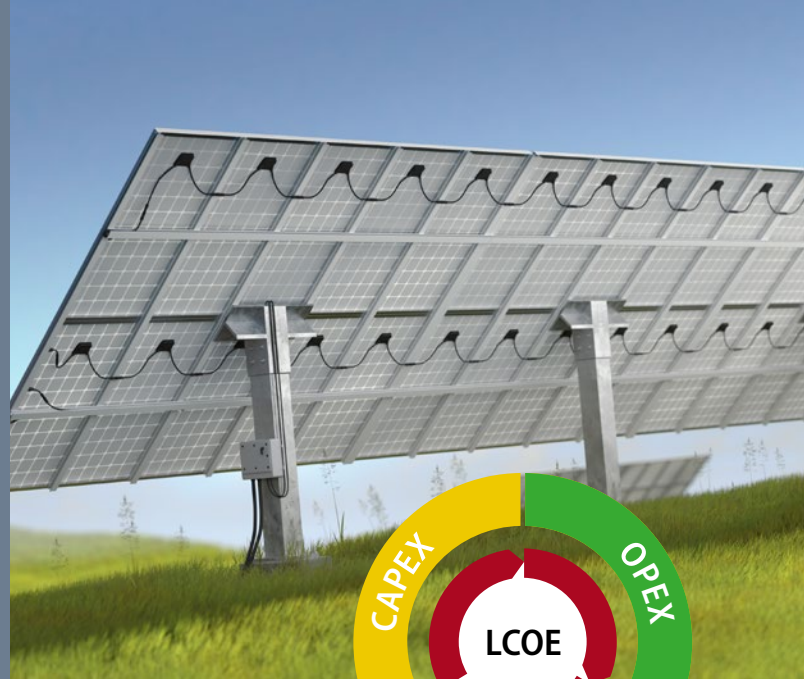

Services & Support

Keep your systems running at peak performance. Get support for your transformation journey every step of the way by working with a trusted Support- and Service engineers

Intelligent Cable Routing Management

(iCRM) software applications implement, manage and maintain structured cabling systems for PhotoVoltaic Power Plants. It combines an "intelligent" DC-Cable Routing to manage the physical layer of DC cable Network of PV Power Plants.

Application

Optimized for Floating PV Power Plant,
Industrial and Utility Power Plants

iC/DC Cabling product portfolio

inter Connectivity for DC cabling

iC/DC Cabling Looming Cable System

Conventional Cabling System

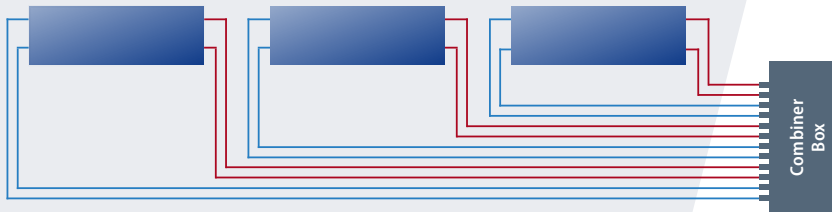

LEONI Interconnectivity DC String Cabling System

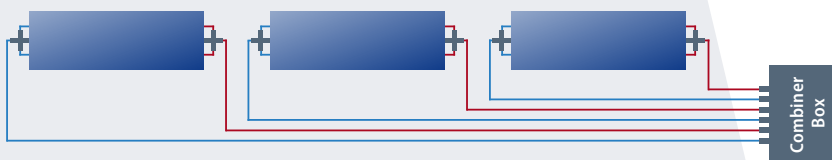

- Solar project specific solutions
- 50 % reduction of installation cables
- 25 % reduction of connectors
- 50 % reduction of installation time
- Smaller PV array junction box possible
- In-line fuses and diodes can be integrated directly into the cable

iC/DC Cabling Branch Distributor & Connectors & Looming Cables

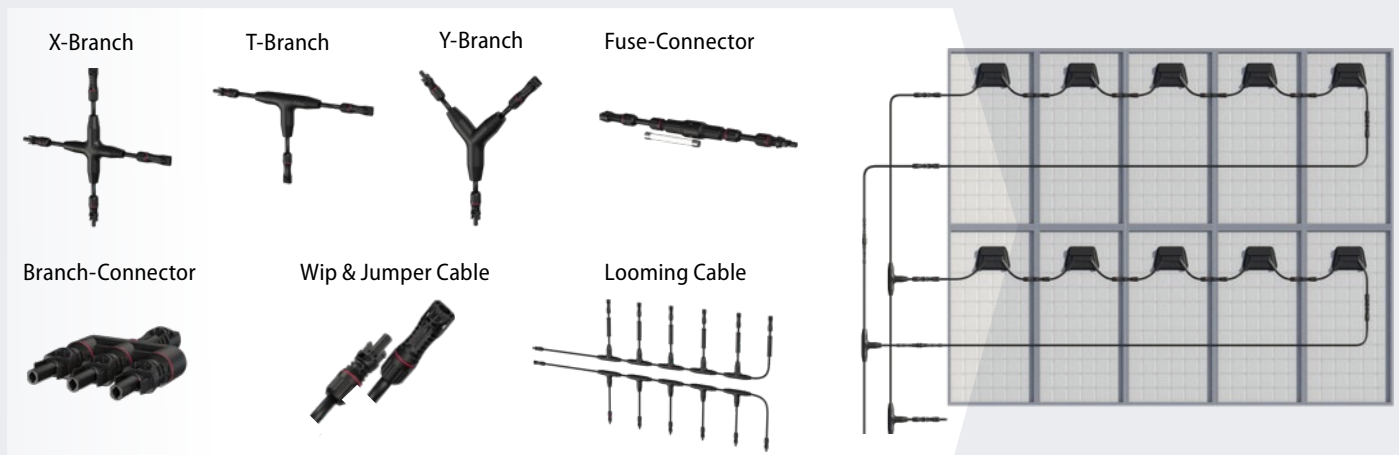

iC/DC Cabling Highlights & Specifications

- LEONI PV Cable, BETAflam® Solar 125 flex, EN 50618, 1500V DC, E-beam cross linked, 4–6–10 mm², with high adhesiveness (patent pending)
- SOLARpower Alu – Ata, direct burial, radial humidity (barrier) resistant, termite and rodent protected
- Due to the high adhesiveness, cable can achieve vulcanized connection with overmoulding material (Junction), 100 % long time waterproof
- All Accessories (e.g. Connector, terminal grounding kit, installation tool) with matched components from the market leaders, achieve best installation and quality results
- Outstanding System durability and reliability
- Extensive quality testing & Service expectancy over 25 years
- Less junctions and fewer string-cable through intelligent Cable Routing Management (iCRM)
- Global presence of LEONI factories and partners for JIT deliveries

DC solutions by LEONI and Weidmüller

Complete coordinated, reliable and durable system

LEONI

Weidmüller

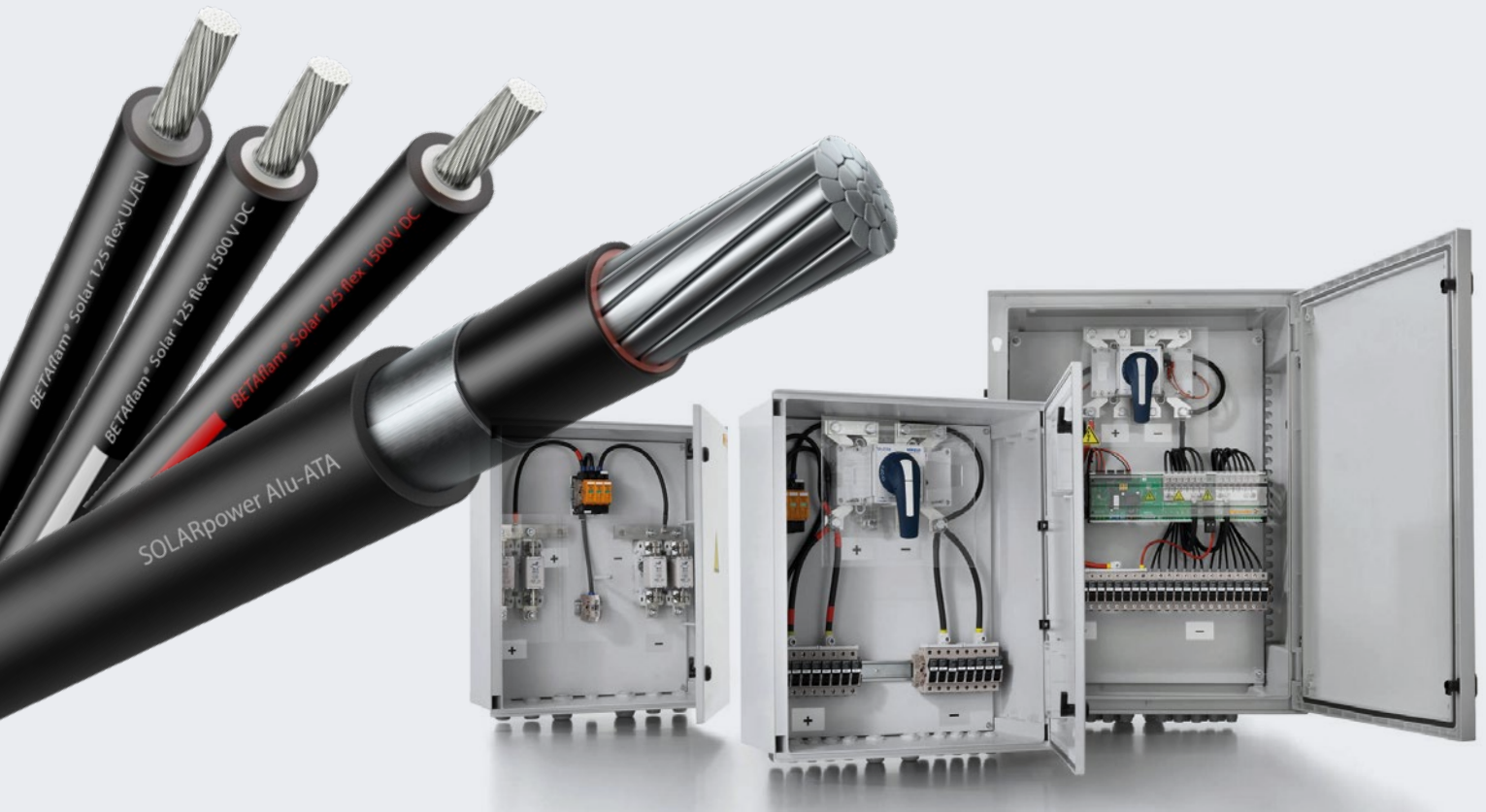

LEONI BETAflam®
and SOLARpower Alu-ATA XS solar cables

Weidmüller Combiner Boxes

LEONI Solar & Windpower offers reliable, optimised system solutions. This includes cables and inverter – a system from a single source through just one point of contact.

To meet this need, we have formed a partnership with Weidmüller, bringing the customers real benefits and uncompromised reliability.

Weidmüller's generator connection cabinet for solar systems subscribes to the same philosophy as that followed by LEONI in its solar cables:

- State-of-the-art development and production standards
- Extremely high standards of quality
- Made-to-measure solutions
- Worldwide availability
- Sustainability

This joint system solution from LEONI and Weidmüller offers our customers a system that is tested, coordinated, reliable and durable; it also meets all current standards worldwide.

Technical information





DC solutions & cables

Technical information – DC solutions & cables		Page
Max. current rating for BETAflam® Solar & Alu-ATA cables		28
Standard packaging / Transport conditions	Packaging	29
	Distribution, storage, availability	29
Smoke density		30
Flame retardance		30
Halogen-freeness		31
Degree of acidity of combustion gases		31
Electron-beam cross-linking	Physical cross-linking	32
	Cross-linked insulating materials	32
	Advantages of cross-linked insulation materials	32
	Temperature index as per IEC 60216 / VDE 0304 part 21	33

Max. current rating for BETAflam® Solar & Alu-ATA cables

Max. current rating for BETAflam® Solar cables

at 120 °C / 248 °F – Ambient temperature 60 °C / 140 °F

Construction	Exposed	On surfaces without contact	On surfaces with contact	In conduit, casing, duct
				
mm ²	Current [A]			
2.5	41	39	33	28
4	55	52	44	36
6	70	67	57	44
10	98	93	79	53
16	132	125	107	80
25	176	167	142	106
35	218	207	176	134
50	276	262	221	166

Conversion factors for different ambient temperatures (base 60 °C)





Temperature °C	Current rating at 120 °C Factor
60	× 1.00
70	× 0.92
80	× 0.84
90	× 0.75

Continuous duty with current loads as per above table.

This results in a conductor temperature of 120 °C (calculation according IEC 60287).

Max. current rating for SOLARpower Alu-ATA cables

at 90 °C / 194 °F

Construction	Suspended in air (60 °C) without sun 	Suspended in air (60 °C) with sun 	Directly buried (max. 20 °C, depth 1m) 	In concrete pipe (max. 20 °C, depth 1 m) 	Max. current rating of the shield*
	Temperature 90 °C				
mm ²	Current [A]				
1 × 50/18	146	124	263	177	40
1 × 70/20	184	155	324	220	44
1 × 95/22	225	189	389	265	48
1 × 120/24	261	218	443	306	52
1 × 150/26	296	246	492	345	54
1 × 185/28	347	287	562	402	61
1 × 240/31	408	337	652	466	64
1 × 300/33	475	390	738	533	66
1 × 400/39	562	459	848	650	68
1 × 500/43	659	536	972	750	70

* not valid in case of full load on conductor.

Continuous duty with current loads as per above table. This results in a conductor temperature of 90 °C (calculation according IEC 60287).

Standard packaging / Transport conditions

Packaging

- Wooden packaging acc. to the IPPC ISPM-15 standard (Bew. Nr. CH-90055-HT-DB): All pallets and plywood reels acc. to IPPC standard ISPM15, the producer is registered as CH-90055-HT-DB.
- Fit for sea, air and land transport
- Can be stacked 2-high

Distribution, storage, availability

Customers of LEONI receive their BETAflam® Solar deliveries on schedule from the standard stock in Germany. Large buffer stocks are available there to ensure flexibility. Currently, LEONI manages several individual customer stocks across the world in order to avoid out-of-stock situations in the supply chain. By agreement, suitable purchase contracts can be made to create further buffer stocks on a worldwide basis, which can be tailored and managed to individual requirements.

Standard reel dimensions

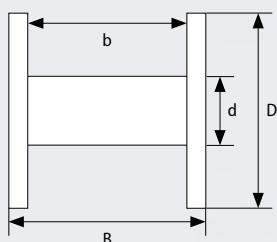

Reel	Flange		Distance between flange	
	D	d	external B	internal b
	cm	cm	cm	cm
H30	30	12	30	29
H40	40	18	30	27
H50	50	15	43	40
K10	100	50	70	60
K20	200	100	114	100

Standard packaging units / pallet

Pallet	Dimensions W×D×H		Load
	cm	inch	Reel / Pallet
V1	100×120×~80	39.4×47×~32	24×H30
V2	80×120×~105	31.5×47×~41	18×H40
V3	100×100×~101	39.4×39.4×~40	8×H50
V4	100×100×~85	39.4×39.4×~34	1×K10

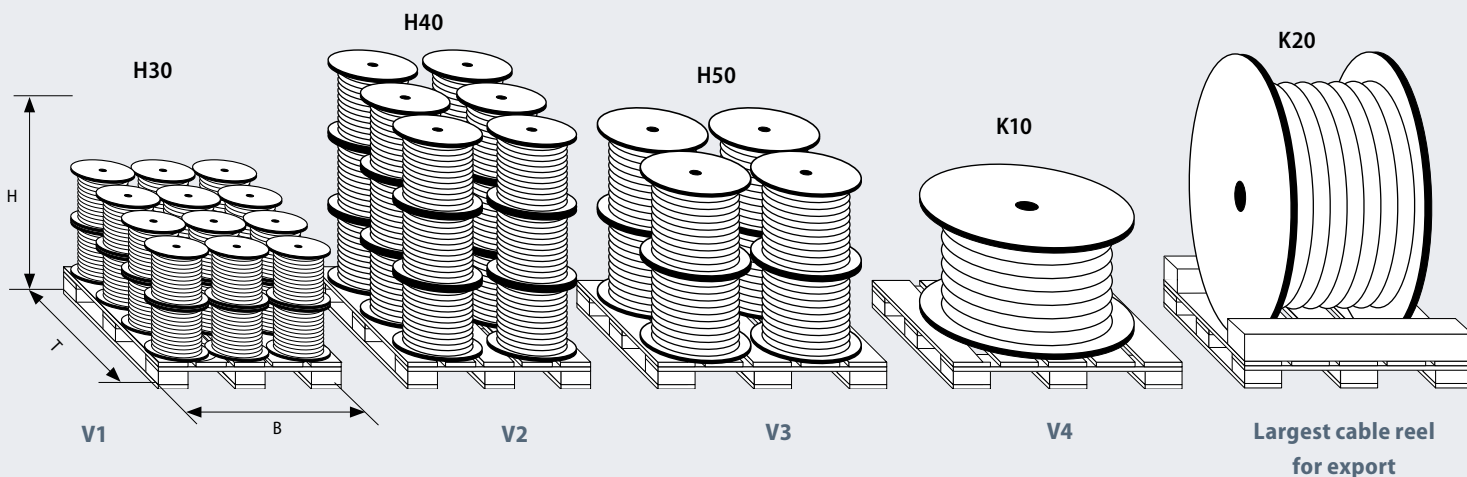

Smoke density

The formation of smoke has several unpleasant consequences. On the one hand it considerably lowers the visibility in a fire event, thus impeding the people trapped inside closed rooms escape of and the efforts of the firemen to carry on their rescue and fire fighting actions. On the other hand it produces smoke poisoning because of the carbon monoxide. With respect to the formation of combustion gases, PVC performs rather poorly. However, this cannot be blamed on PVC, as is frequently assumed. In fact, it is caused by the additives included in the PVC – particularly the softening agents, which normally lead to considerable smoke production.

Test procedures

The density of smoke emission can be determined by measuring of the light penetrability. Cable samples are lit with alcohol in a test chamber (cubical with an edge length of 3 m). The so formed smoke is uniformly spread by a ventilator and influences the light measuring section.

The test is considered to be passed if the following light penetrability is REACHED:

Hazard level	Requirements
■ HL 1	–
■ HL 2 and HL 3	60 %
■ HL 4	70 %

Test standards

IEC 61034, EN 61034

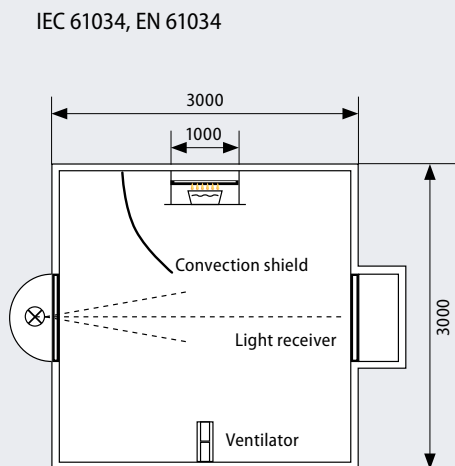

Flame retardance

Flame retardant cables are cables which, when installed as a single cable, although ignitable on exposure to flame source, will greatly reduce flame spread and self-extinguish once the flame source is removed.

However in a vertical cable bundle, e.g. in vertical risers, fire can spread along the cables (chimney effect). In order to avoid this danger, the so called «no flame propagating» cables should be used.

Test procedures

This test procedure describes the minimum requirements for flame retardant cables and it is valid for lead wires or on single cables only.

A lead wire or a cable is being aflamed with a propane-air-burner (1 kW flame).

Test duration

■ $\varnothing \leq 25$	= 60 s
■ $\varnothing 25 \dots 50$	= 120 s
■ $\varnothing 50 \dots 75$	= 240 s
■ $\varnothing > 75$	= 480 s

The burning cable should self-extinguish as soon as the fire source has been removed. The fire damage may not be higher than 60 cm.

The test is considered to be passed if the sample has not burned and the damage (carbonisation) has not REACHED any of the terminations of the sample (> 50 mm). Additional test procedures for individual cables are also undertaken in accordance with UL 1581.

Test standards

IEC 60332-1, EN 60332-1

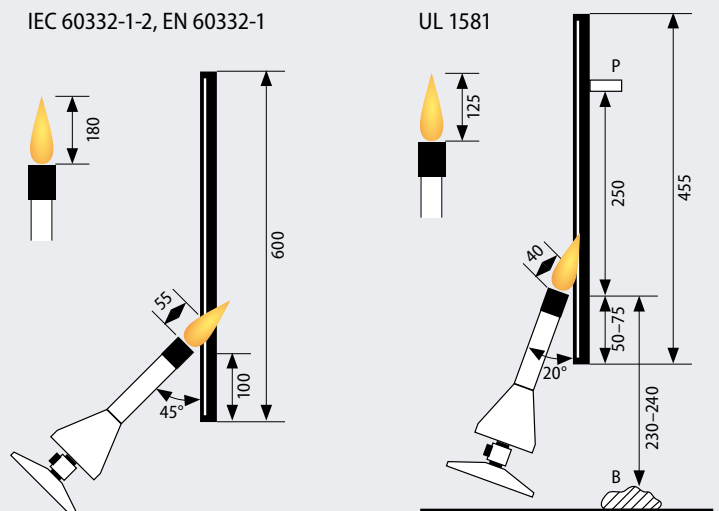

Halogen-freeness

The halogens are the elements of the 7th group in the Periodic table of elements:

- **Chlorine (Cl)**
- **Fluorine (F)**
- **Bromine (Br)**
- **Jodine (I)**

Halogen-free cables must be free of chlorine, fluorine and bromine (PVC cables contain halogen, PVC = Polyvinylchloride).

The halogens are an integrated component of many acids.

- **HCl = Hydrochloric acid, salt acid**
- **HF = Hydrogenfluorid**
- **HBr = Hydrogenbromid**

The most popular plastic containing halogens is PVC (polyvinylchloride). In case of fire or at high temperature PVC starts to degradate. Hydrochloric acid and other fission products are generated and leads to extremely aggressive corrosion. Therefore the current trend is to replace the halogen containing plastics with halogen-free ones. For instance PVC is currently being replaced at a large scale with polyolefin i.e. polyethylene.

Thanks to halogen-free cables the formation of corrosive and toxic gases can be prevented.

Test procedures

A sample of between 0.5 g and 1.0 g is heated in a tube.

The resulting gases are released and tested for their halogen content. Using this process, all halogen-based acids, with the exception of hydrofluoric acid, are separated as hydrochloric acid.

Test standards

IEC 60754-1

Degree of acidity of combustion gases

Corrosive gases react with moisture to produce aggressive acids which corrode metal parts and cause extensive long-term damage, even though the fire damage may only be limited; this is because corrosive gases often spread throughout a building through the ventilation system or withing whole installations. The damage may not be limited to the area immediately affected by the fire. Electronic units and electronic contacts are particularly vulnerable, as are free-standing or concrete enclosed steel constructions.

Test procedures

1000 mg insulation material is burned in a combustion furnace at ≥ 935 °C with pre-defined air supply for over 30 minutes. By means of two gas washing containers, held in the airflow the conductivity and the pH-value are measured. Like that even small quantities of halogen containing substances can be detected and proven.

The test is considered to be passed if

- **the PH value > 4.3**
- **the conductivity < 10 μ S/mm**

Test standards

IEC 60754-2, EN 50267-2-2

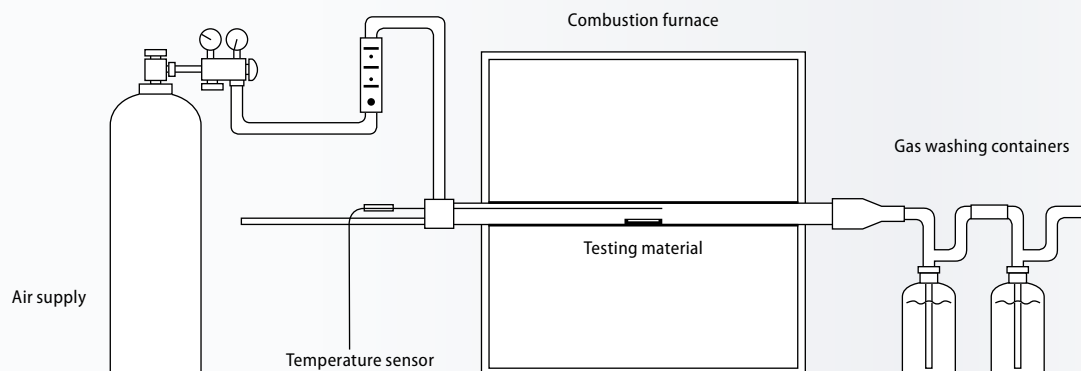

Electron-beam cross-linking

Physical cross-linking

We cross-link our cable insulations with highenergy electrons (betarays) in our own state-of-the-art irradiation centre. These electrons cede their kinetic energy when slowed down in the polymer. Through the impact of the electrons radicals are built, which with chemical reaction interlink the molecules.

Cross-linked insulating materials

Cross-linking binds together the polymer chains by means of a chemical linking (in the amorphous phase).

This leads to a three-dimensional network. The polymer chain can no longer move freely (irrespective of temperature). Above the melting temperature the material can no longer flow but it goes into a rubber-like elastic state.

Advantages of cross-linked insulation materials

- Increased shear and compressive strength
- Improved integrity in case of electrical failures (overload, short circuit)
- Improved resistance to chemicals
- Infusible, soldering iron resistance
- Improved impact strength and crack resistance
- Better weather and abrasionresistance

With the electron-beam accelerators the insulation materials can be cross-linked within a few seconds. The homogenous irradiation and implicit the homogenous cross-linking are ensured by thererfore especially adapted handling systems. Other than in the chemical cross-linking in the irradiation cross-linking no peroxides or hydro-silicones are incorporated into the synthetic mixtures.

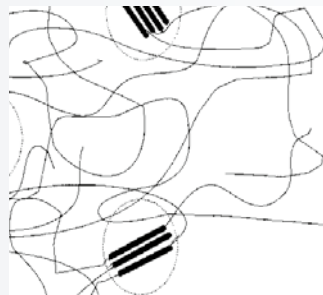
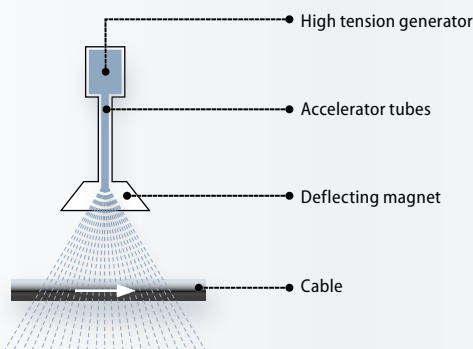

BEFORE cross-linking:
Schematic representation of the chain-forming macromolecules before cross-linking. Free movement of polymer chains (in the melt and in the solution).

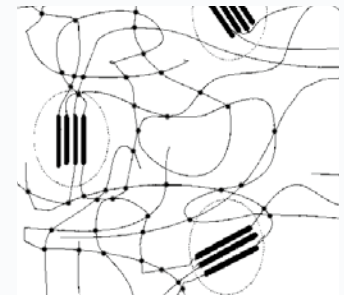

AFTER cross-linking:
Schematic representation of chain-forming macromolecules after cross-linking. Three-dimensional cross-linking of polymer chains (heavily impaired freedom of movement).

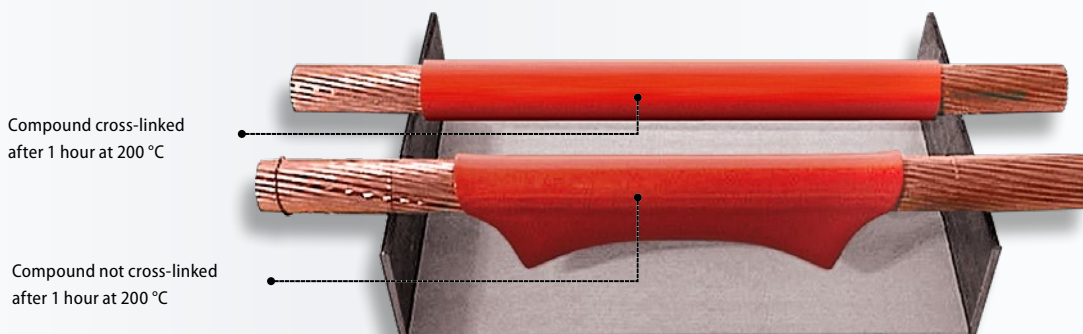

Electron-beam cross-linking

Temperature index as per IEC 60216 / VDE 0304 part 21

The temperature index describes the long-term performance of plastics. The temperature index defines the ageing temperature (in °C), at which the material still has an absolute elongation at break of 50% after 20,000 hours. A 10 °C higher temperature index results in approximately doubling the service life expectation of the plastic.

By prolonging the straight line until it intersects the 20,000 h axis it is possible to determine the service life or the temperature index.

In order to determine the long term temperature stability of an insulation material the different ageing times corresponding to different temperatures are measured and recorded in a so called Arrhenius-Diagram (ordinate-axis: log time, abscissa axis: the reciprocal absolute temperature). A straight line is drawn to connect the various recorded points.

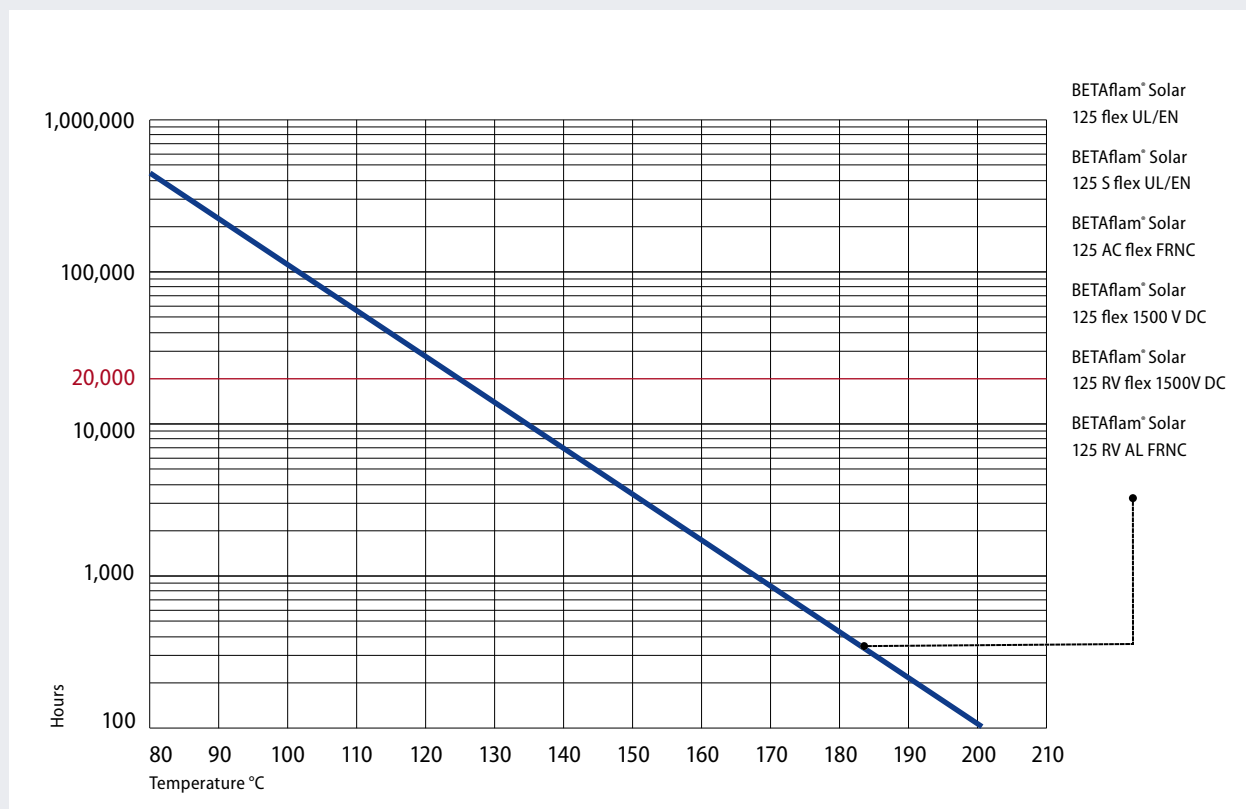

LEONI – the all-in-one service provider

For infrastructure, energy and ICT



LEONI – the all-in-one service provider

For infrastructure, energy and ICT

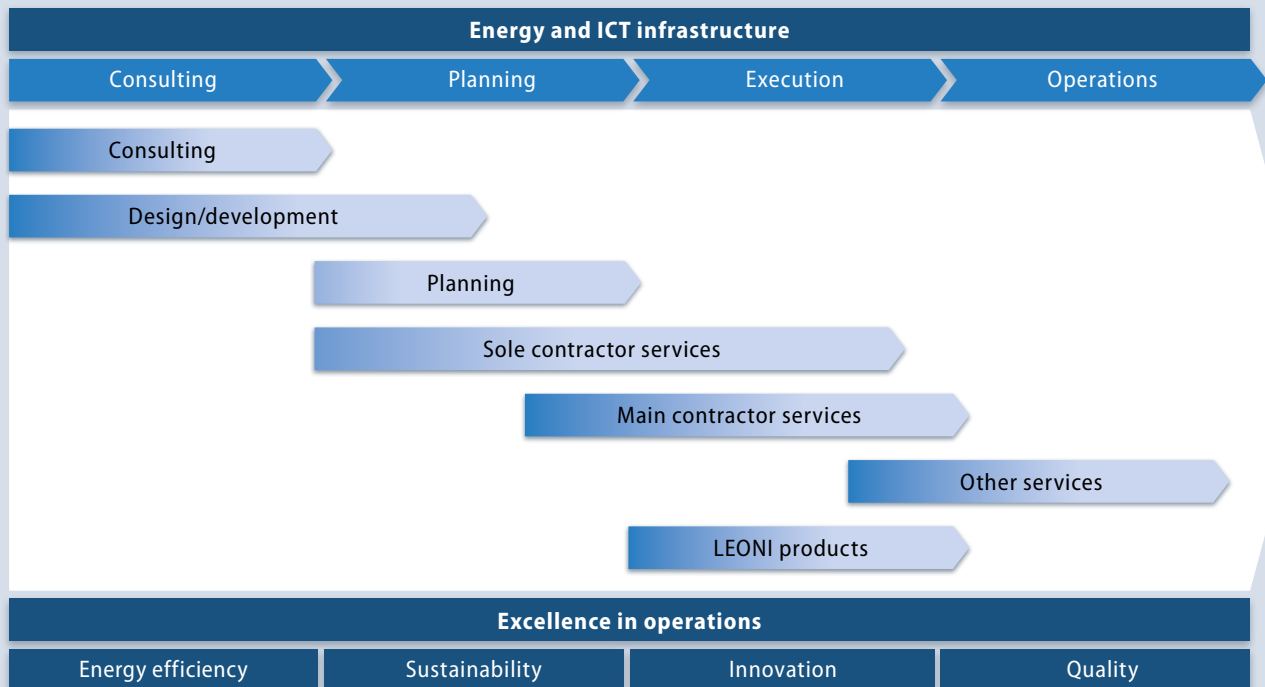

LEONI's department Building Technologies is an innovative and independent supplier of sustainable all-in-one solutions for energy and ICT infrastructure to the international market.

In any project, being able to keep the demands of the various stakeholder groups in balance is critical for project success. Each of these stakeholders is focused on its own competencies and task areas, however.

As a consequence, the client or owner is required to orchestrate these complex interrelationships and keep an eye on everything. This is where LEONI can help by ensuring the optimal coordination of the various subject areas, bringing together industry-wide know-how under one roof, in a team staffed by engineers, technical architects, security consultants and construction supervisors. A well-developed project management system and tailor-made software tools provide a high degree of plannability, resulting in important cost savings in the implementation phase, with a significantly reduced level of project risk.

With its highly focused service portfolio, LEONI can offer you additional services to optimise your long-term capital investment and operating costs.

Building Technologies offers the perfect combination of

- **cable manufacturer,**
- **engineering company,**
- **plant integrator and**
- **service provider.**

It is this combination that enables the unit to handle the complex requirements customers face both today and tomorrow.

We create solutions for you that offer all-round satisfaction.

Phone +41 62 288 82 82

building-technologies@leoni.com

www.leoni-energy-infrastructure.com

LEONI DC Solutions

Approved and certified quality



Zertifikat

Zertifikat No. / Certificate No. R 60134585

Blatt / Sheet 0002

Our Zeichen / Client Reference: Unser Zeichen Our Reference: 0010--60143840 001

Anstellungsdatum / Date of Issue: 14.12.2018

Geschäftsgliederung / License Holder: LEONI Stüder AG, Herrenmatstr. 20, 4658 Däniken, Schweiz

Fertigungsstätte / Manufacturing Plant: LEONI Stüder AG, Herrenmatstr. 20, 4658 Däniken, Schweiz

Prüfverfahren / Test Method: Geprüft nach / Tested acc. to: 2 PFG 2642/31.17

Zertifiziertes Produkt / Certified Product: PV-Componens für BOS - electrical / PV Aluminiumable for installation in ground

Lizenztyp / License: Einzel / License For - End

Type designation: 1. SOLARpower Outdoor Alu X8, 20
2. SOLARpower Alu-ATA X8, 20

Code designation: PV 15000-AC
Based diameter: 10mm to 40mm
Rated voltage: DC = 1.5 kV d.c.
Temp = 1.5 kV d.c. Conductor-Conductor and Conductor-Busbar

max. Conductor temperature: +90°C (8 20.0083)

Remarks: The PV-cable under 1. is applicable for protected installation in ground.
The PV-cable under 2. is applicable for direct burial.

20

Certificate

Certificate No. CU 72130340 02

License Holder: LEONI Stüder AG, Herrenmatstrasse 20, CH-4658 Däniken, Switzerland

Manufacturing Plant: LEONI Stüder AG, Herrenmatstrasse 20, CH-4658 Däniken, Switzerland

Test report no.: USA-IE 31380172 002
Subject 4703 No. 4 (09-24-2010)
CEN C22.2 90, 271-11

Client Reference: Mr. Faruk Yeginsoy

Certified Product: Photovoltaic wire

License For - Units Change: 1

Model Designation: Betaflam Solar 125 Flex UL/EN (Vest Betaflam Solar 125 flex UL 1030V)

Rated Voltage: 2000 V

Appendix: 1, 1

Issued Test mark: 12/10/2015

Date of Issue (day/month/year)

Zertifikat

Zertifikat No. / Certificate No. R 60123706

Blatt / Sheet 0002

Our Zeichen / Client Reference: Unser Zeichen Our Reference: 0010--21194212 011

Anstellungsdatum / Date of Issue: 26.10.2018

Geschäftsgliederung / License Holder: LEONI Stüder AG, Herrenmatstr. 20, 4658 Däniken, Schweiz

Fertigungsstätte / Manufacturing Plant: Refer to latest revision of the annex list of factories

Prüfverfahren / Test Method: Geprüft nach / Tested acc. to: IEC 62930:2017

Zertifiziertes Produkt / Certified Product: PV-Cables

Lizenztyp / License: Einzel / License For - End

Announcement: The PV-cable mentioned on page 1 meets the requirements of the above mentioned standards.

Certificate

Certificate No. R 60100611

License Holder: LEONI Stüder AG, Herrenmatstr. 20, 4658 Däniken, Schweiz

Manufacturing Plant: LEONI Stüder AG, Herrenmatstr. 20, 4658 Däniken, Schweiz

Our Zeichen / Client Reference: Unser Zeichen Our Reference: 0010--21194212 004

Anstellungsdatum / Date of Issue: 08.05.2015

Anstellungsdatum / Date of Issue: 14.04.2015

Geschäftsgliederung / License Holder: LEONI Stüder AG, Herrenmatstr. 20, 4658 Däniken, Schweiz

Fertigungsstätte / Manufacturing Plant: LEONI Stüder AG, Herrenmatstr. 20, 4658 Däniken, Schweiz

Prüfverfahren / Test Method: Geprüft nach / Tested acc. to: EN 50618:2014

Zertifiziertes Produkt / Certified Product: PV-Leitungen

Lizenztyp / License: Einzel / License For - End

Bezeichnung: BETAflam * Solar 125 flex UL/EN, 14

Neuarturbezeichnungen: H1222-K
Nennausgangsspannung: DC 1500V
Umgebungstemperatur: -40°C bis +90°C
Max. Leitertemperatur: +120°C (8 20.008)

Material Isolierhülle: Stüder Compound 7025 K160 (Gelb, schwarz, rot, blau)

Material Mantel: Stüder Compound 7025 + 755 K160

Die oben genannte PV-Leitung erfüllt auch die Anforderungen der 2PFG 1990/05.12

14

Zertifikat

Zertifikat No. / Certificate No. R 60131173

Blatt / Sheet 0001

Our Zeichen / Client Reference: Unser Zeichen Our Reference: 0010--21194212 005

Anstellungsdatum / Date of Issue: 08.05.2015

Geschäftsgliederung / License Holder: LEONI Stüder AG, Herrenmatstr. 20, 4658 Däniken, Schweiz

Fertigungsstätte / Manufacturing Plant: LEONI Stüder AG, Herrenmatstr. 20, 4658 Däniken, Schweiz

Prüfverfahren / Test Method: Geprüft nach / Tested acc. to: EN 50618:2014

Zertifiziertes Produkt / Certified Product: PV-Cables for PV-Systems with 1500 V DC

Lizenztyp / License: Einzel / License For - End

Type designation: BETAflam* Solar 125 flex 1500V DC, 14

Code designation: H1222-K
Based diameter: 2,5mm ; 4,0mm ; 6,0mm ; 10,0mm
Rated voltage: DC 1500 V
Single conductor: 49,7A
Ambient temperature: -55°C to +90°C
max. core temperature: +120°C (8 20.008)

Material of insulation: Stüder compound 7025 (natural, black, red, blue)
Stüder compound 7025 (black)

Material of sheath: Stüder compound 7025 (black)

Remarks: The above mentioned PV cable fulfills also the requirements of the 2PFG 1990/05.12
Replaced certificate R 6003198

14

Certificate

Certificate No. R 60100611

License Holder: LEONI Stüder AG, Herrenmatstr. 20, 4658 Däniken, Schweiz

Manufacturing Plant: LEONI Stüder AG, Herrenmatstr. 20, 4658 Däniken, Schweiz

Our Zeichen / Client Reference: Unser Zeichen Our Reference: 0010--21194212 004

Anstellungsdatum / Date of Issue: 08.05.2015

Anstellungsdatum / Date of Issue: 14.04.2015

Geschäftsgliederung / License Holder: LEONI Stüder AG, Herrenmatstr. 20, 4658 Däniken, Schweiz

Fertigungsstätte / Manufacturing Plant: LEONI Stüder AG, Herrenmatstr. 20, 4658 Däniken, Schweiz

Prüfverfahren / Test Method: Geprüft nach / Tested acc. to: EN 50618:2014

Zertifiziertes Produkt / Certified Product: PV-Leitungen

Lizenztyp / License: Einzel / License For - End

Bezeichnung: BETAflam * Solar 125 flex UL/EN, 14

Neuarturbezeichnungen: H1222-K
Nennausgangsspannung: DC 1500V
Umgebungstemperatur: -40°C bis +90°C
Max. Leitertemperatur: +120°C (8 20.008)

Material Isolierhülle: Stüder Compound 715 K160 (Gelb, schwarz, rot, blau)

Material Mantel: Stüder Compound 7025 + 755 K160

Die oben genannte PV-Leitung erfüllt auch die Anforderungen der 2PFG 1990/05.12

14

Zertifikat

Zertifikat No. / Certificate No. R 60123706

Blatt / Sheet 0002

Our Zeichen / Client Reference: Unser Zeichen Our Reference: 0010--21194212 011

Anstellungsdatum / Date of Issue: 26.10.2018

Geschäftsgliederung / License Holder: LEONI Stüder AG, Herrenmatstr. 20, 4658 Däniken, Schweiz

Fertigungsstätte / Manufacturing Plant: Refer to latest revision of the annex list of factories

Prüfverfahren / Test Method: Geprüft nach / Tested acc. to: IEC 62930:2017

Zertifiziertes Produkt / Certified Product: PV-Cables

Lizenztyp / License: Einzel / License For - End

Announcement: The PV-cable mentioned on page 1 meets the requirements of the above mentioned standards.

Certificate

Certificate No. R 60100611

License Holder: LEONI Stüder AG, Herrenmatstr. 20, 4658 Däniken, Schweiz

Manufacturing Plant: LEONI Stüder AG, Herrenmatstr. 20, 4658 Däniken, Schweiz

Our Zeichen / Client Reference: Unser Zeichen Our Reference: 0010--21194212 004

Anstellungsdatum / Date of Issue: 08.05.2015

Anstellungsdatum / Date of Issue: 14.04.2015

Geschäftsgliederung / License Holder: LEONI Stüder AG, Herrenmatstr. 20, 4658 Däniken, Schweiz

Fertigungsstätte / Manufacturing Plant: LEONI Stüder AG, Herrenmatstr. 20, 4658 Däniken, Schweiz

Prüfverfahren / Test Method: Geprüft nach / Tested acc. to: EN 50618:2014

Zertifiziertes Produkt / Certified Product: PV-Leitungen

Lizenztyp / License: Einzel / License For - End

Bezeichnung: BETAflam * Solar 125 flex UL/EN, 14

Neuarturbezeichnungen: H1222-K
Nennausgangsspannung: DC 1500V
Umgebungstemperatur: -40°C bis +90°C
Max. Leitertemperatur: +120°C (8 20.008)

Material Isolierhülle: Stüder Compound 715 K160 (Gelb, schwarz, rot, blau)

Material Mantel: Stüder Compound 7025 + 755 K160

Die oben genannte PV-Leitung erfüllt auch die Anforderungen der 2PFG 1990/05.12

14

Zertifikat

Zertifikat No. / Certificate No. R 60131173

Blatt / Sheet 0001

Our Zeichen / Client Reference: Unser Zeichen Our Reference: 0010--21194212 005

Anstellungsdatum / Date of Issue: 08.05.2015

Geschäftsgliederung / License Holder: LEONI Stüder AG, Herrenmatstr. 20, 4658 Däniken, Schweiz

Fertigungsstätte / Manufacturing Plant: LEONI Stüder AG, Herrenmatstr. 20, 4658 Däniken, Schweiz

Prüfverfahren / Test Method: Geprüft nach / Tested acc. to: EN 50618:2014

Zertifiziertes Produkt / Certified Product: PV-Cables for PV-Systems with 1500 V DC

Lizenztyp / License: Einzel / License For - End

Type designation: BETAflam* Solar 125 flex 1500V DC, 14

Code designation: H1222-K
Based diameter: 2,5mm ; 4,0mm ; 6,0mm ; 10,0mm
Rated voltage: DC 1500 V
Single conductor: 49,7A
Ambient temperature: -55°C to +90°C
max. core temperature: +120°C (8 20.008)

Material of insulation: Stüder compound 7025 (natural, black, red, blue)
Stüder compound 7025 (black)

Material of sheath: Stüder compound 7025 (black)

Remarks: The above mentioned PV cable fulfills also the requirements of the 2PFG 1990/05.12
Replaced certificate R 6003198

14

Certificate

Certificate No. R 60100611

License Holder: LEONI Stüder AG, Herrenmatstr. 20, 4658 Däniken, Schweiz

Manufacturing Plant: LEONI Stüder AG, Herrenmatstr. 20, 4658 Däniken, Schweiz

Our Zeichen / Client Reference: Unser Zeichen Our Reference: 0010--21194212 004

Anstellungsdatum / Date of Issue: 08.05.2015

Anstellungsdatum / Date of Issue: 14.04.2015

Geschäftsgliederung / License Holder: LEONI Stüder AG, Herrenmatstr. 20, 4658 Däniken, Schweiz

Fertigungsstätte / Manufacturing Plant: LEONI Stüder AG, Herrenmatstr. 20, 4658 Däniken, Schweiz

Prüfverfahren / Test Method: Geprüft nach / Tested acc. to: EN 50618:2014

Zertifiziertes Produkt / Certified Product: PV-Leitungen

Lizenztyp / License: Einzel / License For - End

Bezeichnung: BETAflam * Solar 125 flex UL/EN, 14

Neuarturbezeichnungen: H1222-K
Nennausgangsspannung: DC 1500V
Umgebungstemperatur: -40°C bis +90°C
Max. Leitertemperatur: +120°C (8 20.008)

Material Isolierhülle: Stüder Compound 715 K160 (Gelb, schwarz, rot, blau)

Material Mantel: Stüder Compound 7025 + 755 K160

Die oben genannte PV-Leitung erfüllt auch die Anforderungen der 2PFG 1990/05.12

14

Our sales network

We and our competent partners are happy to advise you.

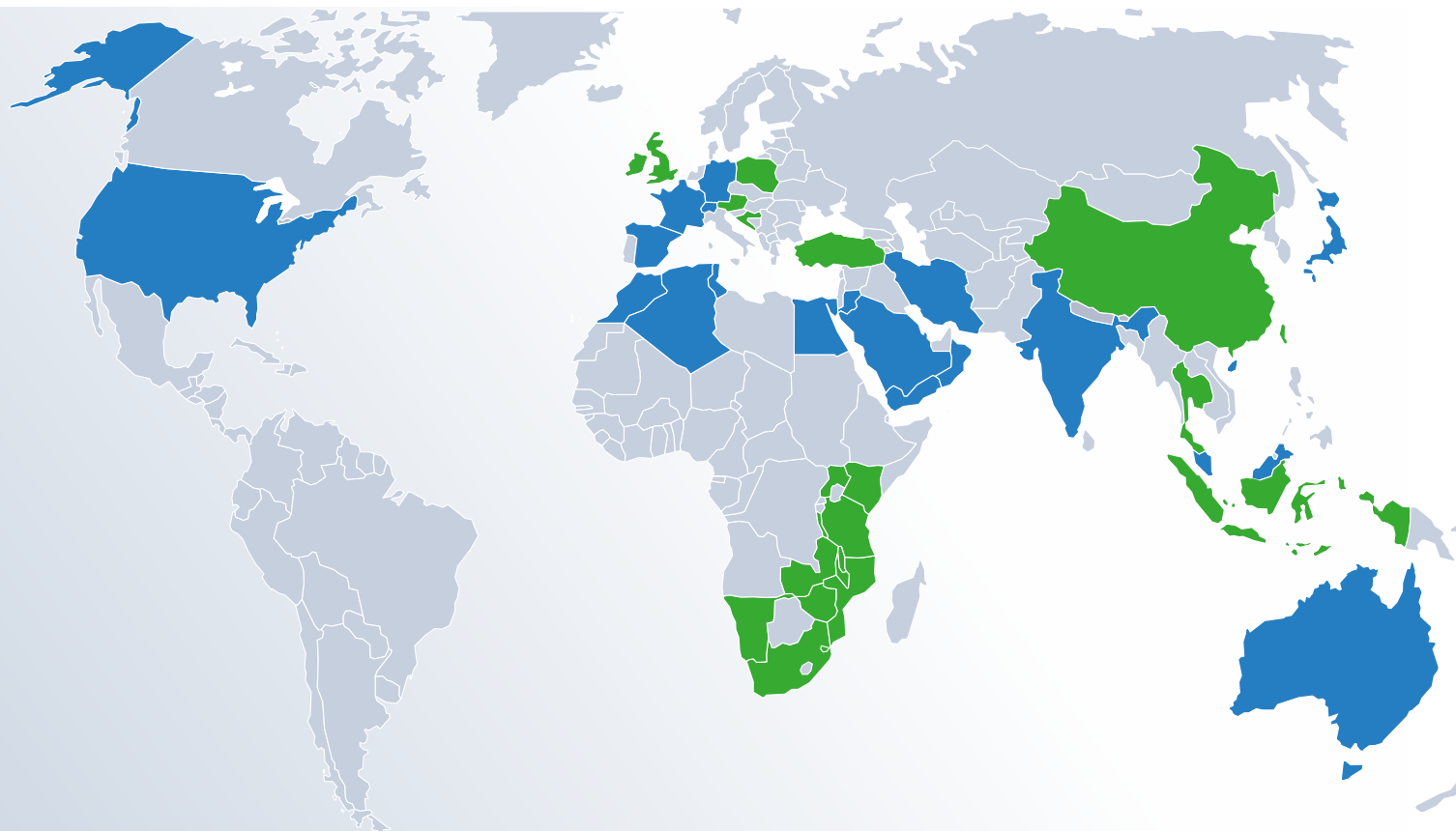

- LEONI Regional Sales Office
- Distributor / Agent

LEONI market segment Energy & Infrastructure

energy-infrastructure@leoni.com

You will find all current information on our sales network online

www.leoni-energy-infrastructure.com



LEONI Studer AG

Herrenmattstrasse 20
4648 Daeniken
Switzerland
Phone +42 62 288 82 82

LEONI Cable Solutions (India) Pvt. Ltd.

Indospace Rohan
Industrial Park Gut No-428
Village-Mahalunge
410501 Taluka Khed
Pune Maharashtra
India
Phone +01 2135 391 661

LEONI (SEA) Pte. Ltd.

No. 9 Tuas Ave. 2
639449 Singapore
Phone +65 91 115 111



Energy & Infrastructure

www.leoni-energy-infrastructure.com

solar-windpower@leoni.com