

**Jinko Solar**

**Installation manual for**

**Photovoltaic Module**

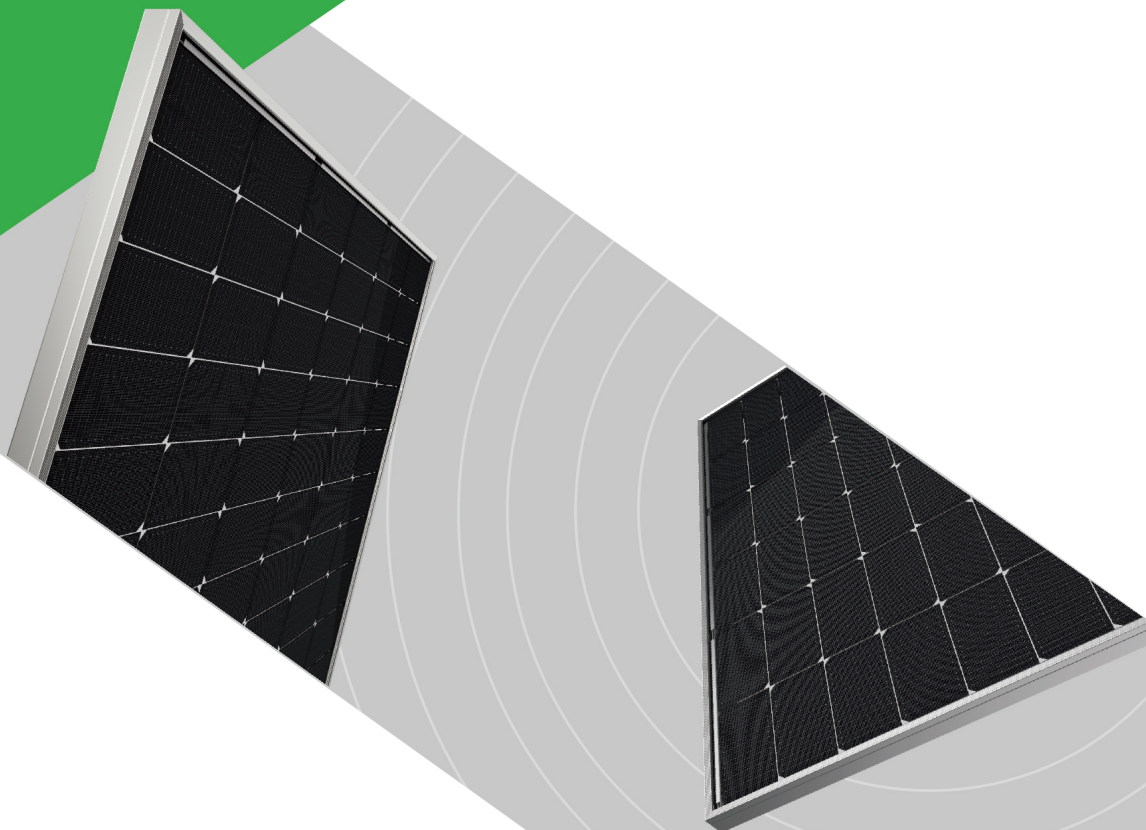

# Contents

1. General Information .....	3
1.1 Overview .....	3
1.2 Warnings .....	3
2. Installation.....	5
2.1 Installation Safety .....	5
2.2 Installation Condition .....	6
2.2.1 Climate Condition .....	6
2.2.2 Site Selection.....	6
2.2.3 Tilt Angle Selection.....	7
2.3 Mechanical Installation.....	8
2.3.1 Fixed installation-mounting with bolts .....	9
2.3.2 Fixed installation-mounting with clamps .....	12
2.3.3 Tracker installation .....	16
3. Wiring and Connection.....	17
4. Maintenance and Care.....	19
5. Electrical Specification .....	21
6. Disclaimer of Liability .....	21

# 1. General Information

## 1.1 Overview

Thanks for choosing Jinko Solar PV modules (hereafter referred to as “modules”). In order to ensure that the PV modules are installed correctly, please read the following instructions carefully before installing and using the modules.

Please remember that PV modules generate electricity and that certain safety measures must be taken to avoid danger.

The application class of modules: Class II (IEC61730:2016); Class A (IEC61730:2004).

## 1.2 Warnings



### Precautions:

- Modules generate DC electrical energy when exposed to sunlight or other light sources. Improper contact with live parts of the module such as terminals can result in burns, sparks, and lethal shock.
- Front glass is used for module protection. Broken glass can cause electrical safety hazard (may cause electric shock or fire). These modules cannot be repaired and must be removed and replaced immediately.
- Breakage of the rear glass (in the case of bifacial PV modules) can also lead to the issue of electrical safety. As in the case of monofacial modules, this cannot be repaired and the modules must be disconnected and replaced immediately.
- The table of specifications is measured under standard test conditions (Irradiance 1000W/m<sup>2</sup>, module cell temperature 25°C, air mass=1.5). The current and voltage generated by modules in different environments are different from those listed in the specification table. Therefore, when determining the specifications of the rated voltage, cable capacity, fuse capacity, controller capacity, and other output power related specifications, take the values of 1.25 times the short-circuit current and open-circuit voltage marked on the module as reference, and consult with your inverter/controller supplier for the system configuration design.
- During all deliveries, ensure that the modules are not subject to big shocks during transportation, which may damage the assembly or cause cracks in the cell of modules.
- When the electrical load is working, do not disconnect modules without authorization; if disconnecting the connector is needed, the DC and AC inverters must be turned off first or the main switch of the converter must be cut off.
- When the battery storage system is connected with the PV system, the battery must be installed correctly, so as to protect the operation of the system and ensure the user safety; Follow the battery manufacturer's instructions for installation, operation, and maintenance.

### Prohibitions:

- Do not apply excessive force or objects on the surface of the module, do not impact, and do not twist the frame of the module, which may damage the cells or cause the cells to crack.
- Do not use the module to replace or partly replace roofs and walls of buildings.
- Do not remove any part installed by Jinko Solar or disassemble the module.
- Don't lift up the modules using the attached cables or the junction box.
- Modules (glass, junction boxes, connectors, etc.) shall be protected from long-term exposure to environments containing sulfur, acid, alkaline, etc., which may pose a risk of corrosion to the product, and organic solvents which can destroy anti-reflection (AR) coating on the front glass or have a negative impact on the polymers as junction boxes and backsheet.
- The junction box must meet IP68 (IEC60529) requirement, however it must be protected from direct sunlight and water immersion. The interconnection of female-male connectors shall meet the IP68 (IEC60529) requirements. However, it is not allowed to use the connector under water for a long time.
- The junction box and the connector shall not be in contact with oily substances, organic solvents and other corrosive materials that may cause functional failure, i.e., alcohol, gasoline, lubricants, rust inhibitors, herbicides, to avoid damage to the junction box and the connector. If the junction box and connector are contaminated, they are forbidden to use.
- Do not stand or step on the module like shown in the below pictures. This is prohibited and there is a risk of damaging the module and injuring the user.



- Do not touch live terminals with bare hands. Use insulated tools for electrical connections.
- Artificially concentrated sunlight shall not be directed onto the module. Do not expose the back of the monofacial module directly to sunlight.

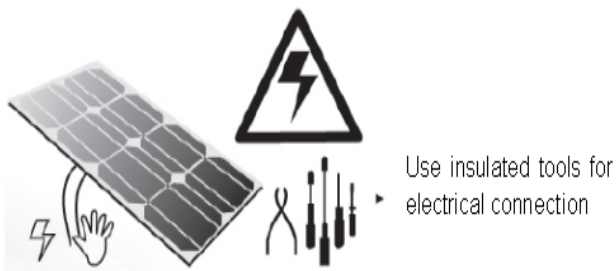

**Others:**

- The maximum altitude of module installation is 2000m.
- The minimum distance from the seashore is 50m (for more info, please refer to 2.2.2). If the distance is less than 50 meters, we recommend using offshore photovoltaic modules, please consult JinkoSolar for details.
- When looking at PV modules with anti-reflection (AR) coating technology, it will be normal to see module with a slight color difference at different angles.
- Before the installation of modules, the modules shall be kept under rainproof facility to avoid direct exposure to rain and sunlight.

- Meaning of crossed –out wheeled dustbin:

Do not dispose of electrical appliances as unsorted municipal waste, use separate collection facilities.

Contact your local government for information regarding the collection systems available.

If electrical appliances are disposed of in landfills or dumps, hazardous substances can leak into the groundwater and get into the food chain, damaging your health and well-being.

When replacing old appliances with new ones, the retailer is legally obligated to take back your old appliance for disposals at least free of charge.

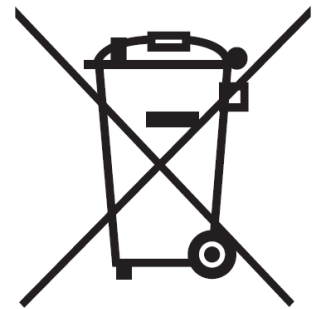

For more, please contact Jinko or refer to the operation and maintenance guideline.

## 2. Installation

### 2.1 Installation Safety

- Always wear safety helmet, insulated gloves, insulated rubber shoes, and other protective measures during installation.
- When installing or maintaining the PV system, please do not wear metal rings, watches and other metal products, so as not to cause electric shock danger and damage the modules.
- Keep the module unpacked until installation. Once the modules are removed from the pallet, they shall be installed and connected to the inverter. If they are not installed immediately, protective measures (such as adding rubber joint cover, etc.) shall be taken on the connection head.
- Do not touch the PV module with bare hands during installation unless necessary. The glass surface and the frame may be hot. There is a risk of burns and electric shock. Use the standard safety tools and equipment when installing the modules.
- Do not work in rain, snowy or windy conditions.

- Due to the risk of electrical shock, do not perform any work if the terminals of the module are wet.
- Use insulated tools and do not use wet tools.
- Only the modules of the same size and the specifications within same range can be connected in series.
- Connect the male and female connectors correctly, check the wiring condition, all wires shall not be detached from the modules, and secure the wires with cable ties so that the wires do not scratch or squeeze the backsheet of the modules.
- Do not touch the junction box or the connectors with bare hands during installation or under sunlight, regardless if the module is connected to or disconnected from the system.
- Do not drill holes in the frame without authorization from Jinko, which may cause corrosion or other negative effects to the module.
- Thermal expansion and cold contraction effect occur on the modules. During installation, the interval between two adjacent modules must be  $\geq 10\text{mm}$ . If there are special requirements, please confirm with Jinko before installation;
- During the installation, as for module removal, maintenance and any other related processes, it is recommended that the force applied between the cable and the connector, and the cable and the junction box to be no more than 60N.
- Do not install the modules anywhere close to open flames or exposed flammable and explosive gases.

## 2.2 Installation Condition

### 2.2.1 Climate Condition

The recommended weather conditions for installing modules are:

- a) Humidity:  $< 85\% \text{ RH}$
- b) Ambient air temperature range:  $-40^{\circ}\text{C}$  to  $+40^{\circ}\text{C}$
- c) Limit working ambient temperature range:  $-40^{\circ}\text{C}$  to  $+70^{\circ}\text{C}$

### 2.2.2 Site Selection

In most applications, Jinko solar PV modules should be installed in a location where they can receive maximum sunlight throughout the year. In the Northern Hemisphere, the module should typically face south, and in the Southern Hemisphere, the modules should typically face north. Modules facing 30 degrees away from due South (or due North) will lose approximately 10 to 15 percent of their power output. If the module faces 60 degrees away from due South (or due North), the power loss will be 20 to 30 percent. Refer to the longitude and latitude of the location to determine the optimal azimuth of the module.

When choosing a site, avoid trees, buildings or obstructions that could create shadows on the modules.



Shading causes loss of power output, even though bypass diodes have been installed for the module, shading will affect the optimum performance and safety issue of the PV modules. Operation in permanent shading conditions is not recommended.

Do not install the PV module near open flame or flammable materials.

Do not install the PV module in a location where it would be immersed in water or continually exposed to water from a sprinkler or fountain etc.

JinkoSolar PV modules have passed the IEC 61701 salt spray corrosion test. PV modules can be installed at a distance of 50m away from the seashore. In the case when the modules are installed within 50m to 500m distance from the seashore, the connectors shall be protected, i.e., adding dust plugs. After removing the dust plugs, connect the connectors immediately and take other anti-rust measures to prevent rust.

For roof-top installations, the roof must be covered with at least one layer of fireproof material suitable for the fireproof class of the PV modules. To facilitate ventilation and heat dissipation of the module, the minimum distance between modules and roof must be  $\geq 10$  cm. Walkways should be reserved for cleaning, repairment and maintenance. For roof-top PV systems, please follow the safety principles of "from top to bottom" and "from left to right". Please use appropriate module components to comply with local laws and regulations, as well as the building fire safety requirements before installation, such as fuses, circuit breakers and grounding connectors, etc...

### 2.2.3 Tilt Angle Selection

The tilt angle of the PV module is measured between the surface of the PV module and a horizontal ground surface (Figure 1). The module generates maximum output power when directly facing the sun.

For standalone systems, the tilt angle of the modules should be selected to optimize the performance based on the season and sunlight. In general, if the module output is adequate when the irradiance is low (i.e., winter), the angle chosen should be adequate during the rest of the year.

For grid-connected systems, modules should be tilted at the angle that the energy production from the modules will be maximized on an annual basis. The Fire Class Rating of a module for roof mounted system shall meet local code requirements in order to achieve the specified System Fire Class Rating for a non-BIPV module.

All PV systems have limitations of inclination required to maintain a specific System Fire Class Rating.

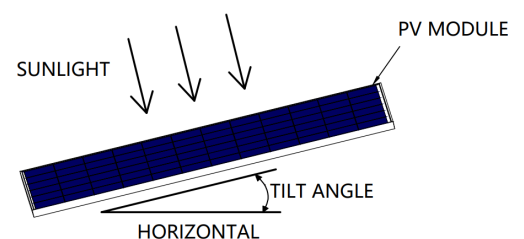

**Fig. 1 PV module tilt angle**

## 2.3 Mechanical Installation

Modules can usually be mounted by using the following methods: fixed installation-mounting with bolts, fixed installation-mounting with clamps and tracker installation.

**\* Note:**

- 1) All installation methods herein are only for reference, and they are based on the test results from third-party tests and Jinko internal tests;
- 2) Jinko solar will not provide related mounting accessories, the system installer or trained professional personnel must be responsible for the PV system's design, installation, and mechanical load calculation and system security.
- 3) Before installation, the following items shall be addressed:
  - a) Visually check the module for any damage. Clean the module if any dirt or residue remains;
  - b) Check if module serial number stickers match.
- 4) The maximum loads that different types of modules can withstand on the front side and back side are dependent on installation methods, which can be referred to Table 2, Table 3 and Table 5. If there is heavy snow and strong wind on the module installation site, take special protection to meet the actual requirements.

**Note: Maximum Test Load = 1.5 (Safety factor) x Design load**

- 5) The module must be mounted on the bracket according to the following installation. If there are other installation, please consult JinkoSolar and obtain approval, otherwise the warranty will be invalid.
- 6) Under the mounting method of the fixed bracket as specified in this manual, the modules will be concave to varying degrees due to the gravity, which is a normal physical phenomenon and does not affect the normal use of the modules. Any other external forces will cause additional sinking of the modules, so any operation of the modules should comply with this manual.



### 2.3.1 Fixed installation-mounting with bolts

Install the module on the rack using anti-corrosion bolts, elastic washers and flat washers with sufficient torque to allow the module to be properly secured. The reference value of tightening torque for M8 bolt is 16-20 N\*M, and for M6 bolt is 9-12 N\*M. If special mounting system or special installation method is required, please reconfirm with the supplier of the racking system regarding the torque value. See Figure 2 for detailed installation information.

See Figure 3 for the module models with corresponding installation positions for bolt installation (using 4 inner holes), Figure 4 for the module models with corresponding installation positions for bolt installation (using 4 outer holes) and Table 1 lists different sizes of bolts for different mounting holes.

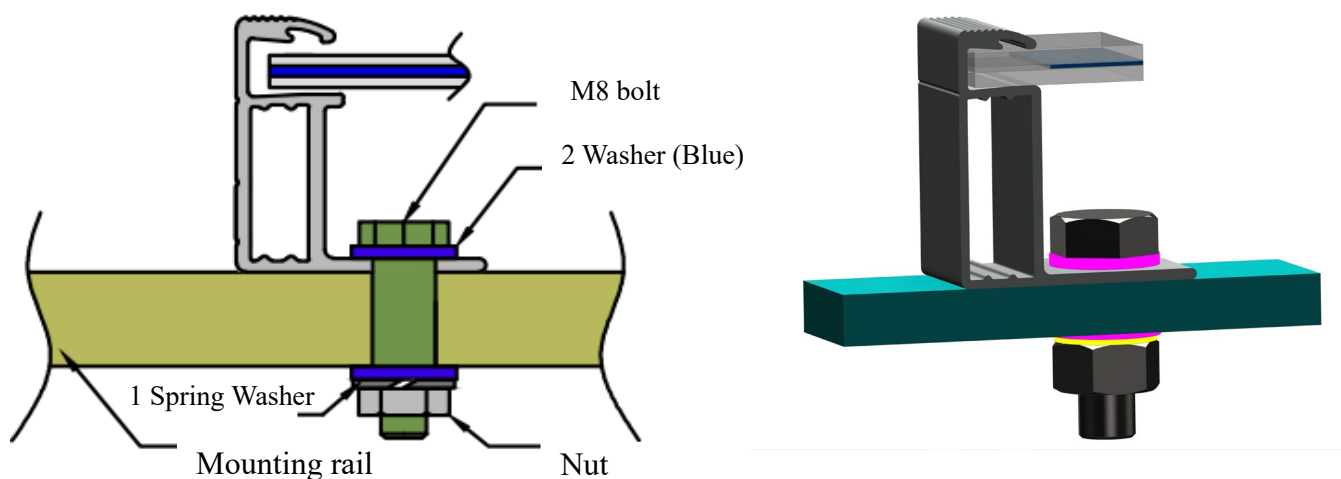

**Fig. 2 Mounting with bolts**

Mounting hole (mm)	Recommended bolt size
14 x 9	M8
10 x 7	M6

**Table 1 Bolts for different mounting holes**

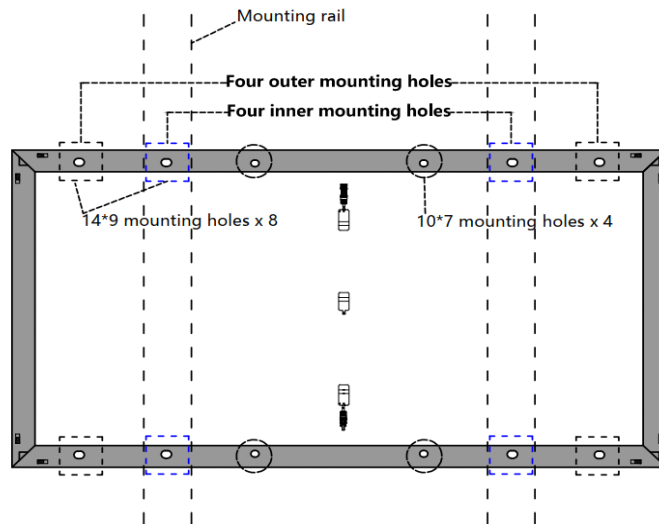

**Fig. 3 Installation with bolt (Four inner mounting holes)**

Module type	Bolt installation (Test Load Pa)
	Four inner mounting holes
JKMxxxN-54HL4-(V) JKMxxxN-54HL4-B JKMxxxN-54HL4R-(V) JKMxxxN-54HL4R-B JKMxxxN-54HL4R-BDV	+6000/-4000
JKMxxxN-78HL4-(V) JKMxxxN-78HL4-BDV JKMxxxN-72HL4-(V) JKMxxxN-72HL4-BDV JKMxxxN-60HL4-(V) JKMxxxN-60HL4R-(V) JKMxxxN-6RL3-(V) JKMxxxN-6RL3-B JKMxxxN-6TL3-(V) JKMxxxN-6TL3-B JKMxxxM-72HL4-BDVP JKMxxxM-72HL4-(V) JKMxxxM-72HL4-TV JKMxxxM-60HL4-(V) JKMxxxM-54HL4-(V) JKMxxxM-7RL3-(V)	+5400/-2400

**Table 2 Test loads under four inner bolt installation methods for different module types**

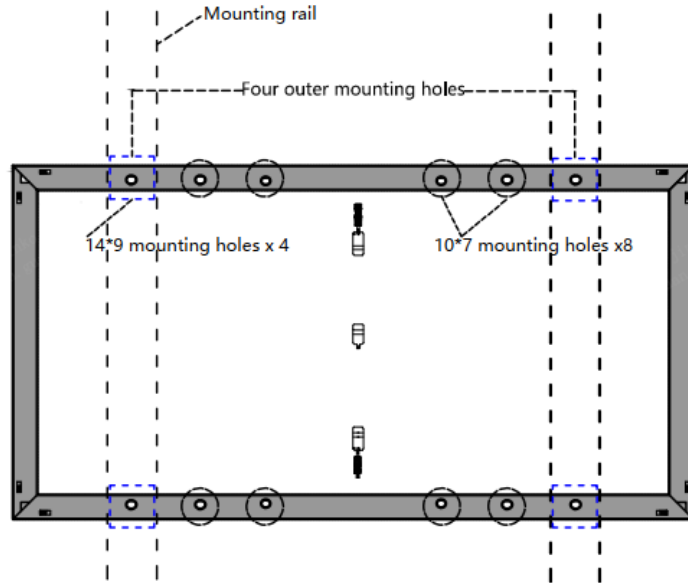

**Fig. 4 Installation with bolt (Four outer mounting holes)**

Module type	Bolt installation (Test Load Pa)
	Four outer mounting holes
JKMxxxN-66HL4M-BDV	+5400/-2400

**Table 3 Test loads under four outer bolt installation methods for different module types**

### 2.3.2 Fixed installation-mounting with clamps

The clamps must not be installed in contact with the front glass of the module and must not deform the module frame. Ensure that the clamps do not create a shadow on the module. Under no circumstances may the frame be altered. When choosing the mounting method for the clamps, make sure that there are at least four clamps on each module. The different mounting positions of the clamps determine the maximum load capacity of the module. Figures 6 - 10 show the different mounting methods and the positions of the clamps for the different mounting methods. Depending on the local wind and snow loads, if there is a possibility of excessive load combinations, additional clamps are required to ensure that the module has enough load carrying capacity. The torque value applied during installation of the clamps should be high enough to securely hold the module (consult installer or bracket supplier for exact torque value). Clamp dimensions and contact area must follow the table, shown in Table 4.

<b>length of the clamp</b>	<b>≥50mm</b>
<b>Overlap of the frame of the module</b>	<b>≥10mm</b>
<b>thicknesses</b>	<b>≥3.0mm</b>

**Table 4 Size of clapm**

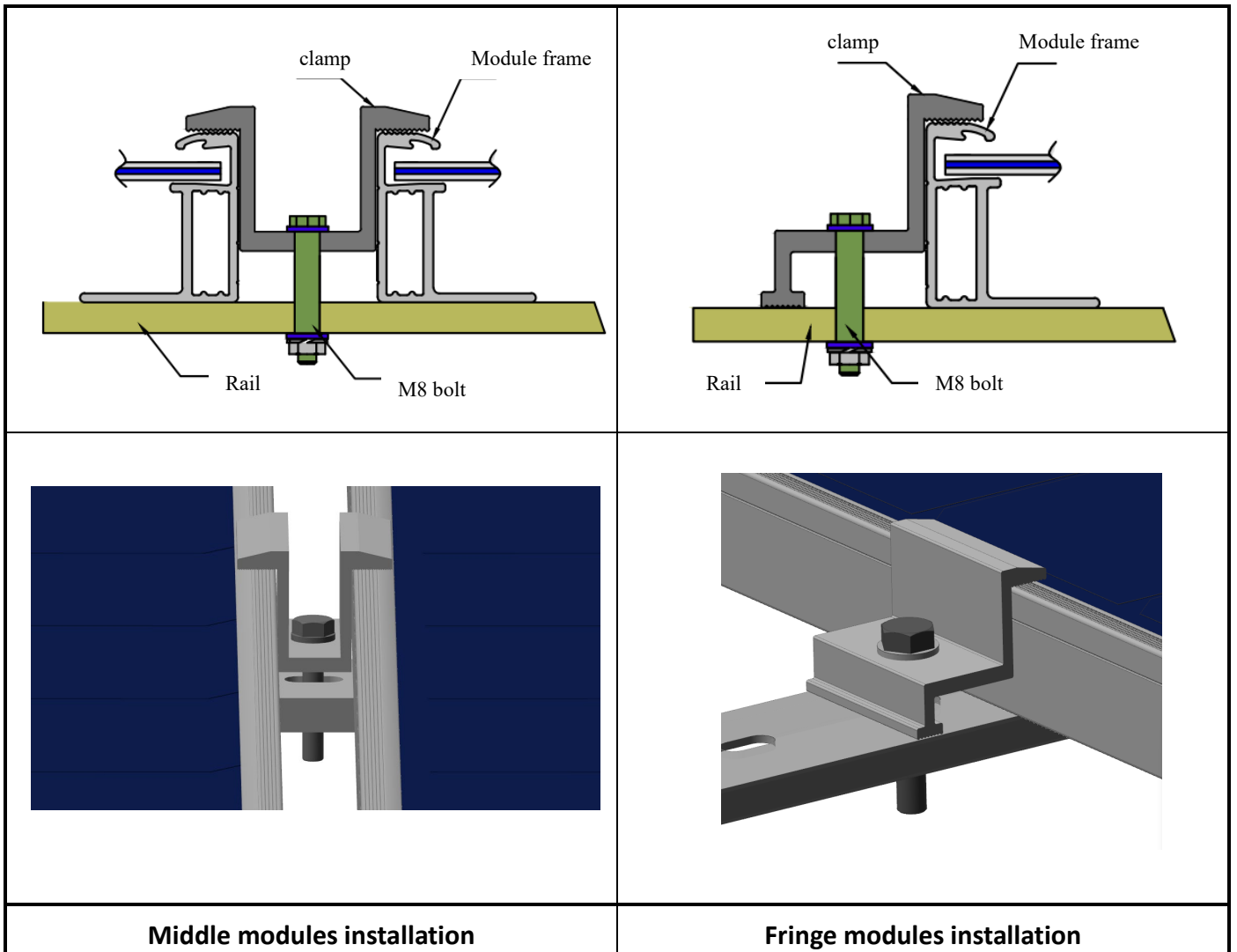

**Fig. 5 PV module installed at the side with Clamp mounting**

### 2.3.2.1 Different methods of clamp installation

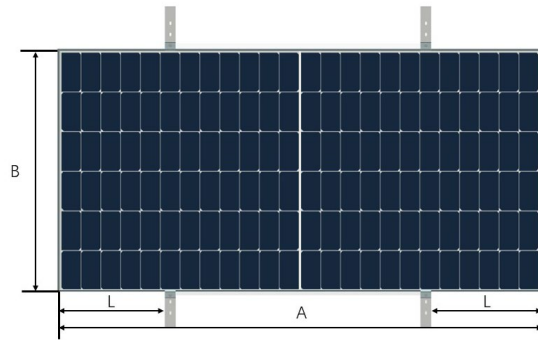

Fig. 6

#### Long side clamp installation

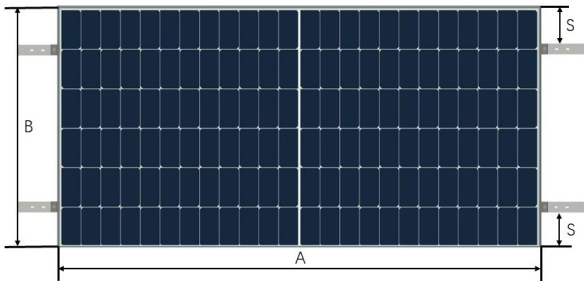

Fig. 7

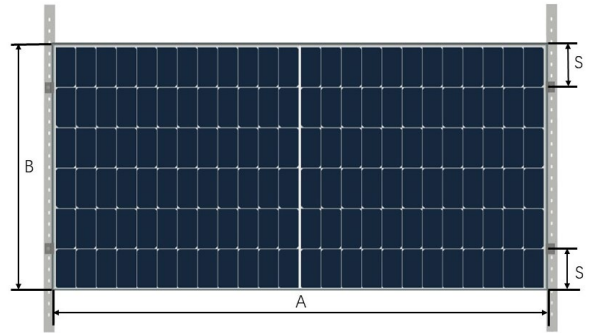

Fig. 8

#### Short side clamp installation

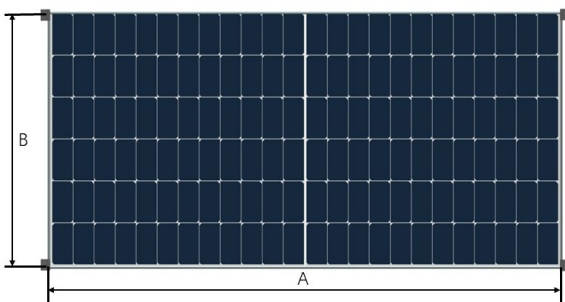

Fig. 9

#### Corner clamp installation(S=0)

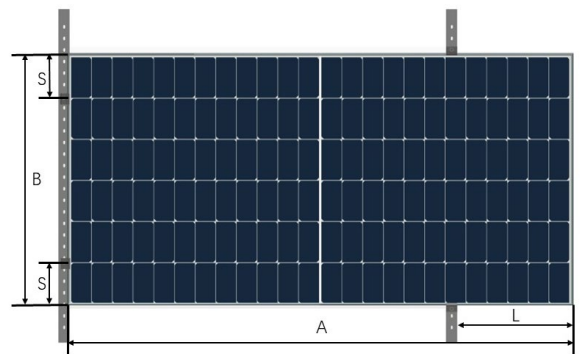

Fig. 10

#### Long & short side clamp installation

Table 5 Clamp Installation

### 2.3.2.2 Mechanical loads for different clamp installation

The installation position under different installation methods for different module types	Clamp installation on long side (+5400Pa, -2400Pa) L in Fig. 6		Clamp installation on short side (±1600Pa) S in Fig. 7, 8	Corner clamping (±1600Pa) Fig. 9	Long & short side clamp installation (±2400Pa) Fig. 10
	30	35	30	30	30
JKMxxxM-54HL4-(V)	A/5±50mm	/	100~240	S=0	S=100~240 L=A/5±50mm
JKMxxxN-54HL4-(V)	A/5±50mm (+6000, -4000)				
JKMxxxN-54HL4-B					
JKMxxxN-54HL4R-(V)					
JKMxxxN-54HL4R-B					
JKMxxxN-54HL4R-BDV					
JKMxxxN-60HL4-(V)	A/5±50mm	/	100~240	S=0	S=100~240 L=A/5±50mm
JKMxxxN-60HL4R-(V)	A/5±50mm	/	100~240	S=0	S=100~240 L=A/5±50mm
JKMxxxM-60HL4-(V)					
JKMxxxN-6TL3-(V)	A/4±50mm	/	100~240	S=0	/
JKMxxxN-6TL3-B	A/5±50mm	/	130~240	/	S=130~240 L=A/5±50mm
JKMxxxN-6RL3-(V)					
JKMxxxN-6RL3-B	/	A/5±50mm	/	/	/
JKMxxxM-72HL4-(V)	A/5~A/4				
JKMxxxM-72HL4-TV	/				
JKMxxxM-7RL3-(V)	/	A/5±50mm	/	/	/
JKMxxxN-78HL4-(V)	/	A/5~A/4	/	/	/
JKMxxxN-72HL4-BDV	A/4±50mm	/	/	/	/
JKMxxxM-72HL4-BDVP	A/4±50mm	/	/	/	/
JKMxxxN-78HL4-BDV					
JKMxxxN-66HL4M-BDV	A/4±50mm	/	/	/	/
Note	A is the length of the long side of the module, B is the length of the short side. For details, please refer to Datasheet.				

**Table 6 Installation dimensions of different module types for clamp mounting**

(Note: for the maximum loads that do not appear in Table 5 for certain installation methods, and for the other installation methods that doesn't appear in Table 6, please contact Jinko for more details.)



### 2.3.3 Tracker installation

Jinko modules also have high compatibility with various mainstream tracker systems in the industry. The maximum load that Jinko module can achieve is as listed in Table 7. (For detailed installation drawings and installation method, please refer to installation manual of tracker supplier. For other tracker systems that are not listed in the table, please contact Jinko customer service department for more information.)

Module type	Tracker system	Installation	Test load (Pa)
JKMxxxN-54HL4-(B)-(V)	ATI 1P	Through bolt clamp 1300/1400mm	+4100/-3200
JKMxxxM-7RL3-(V)	ATI 1P	Hi-rise clamp 400mm	±2100
		Through bolt clamp 1300/1400mm	±3600
JKMxxxM-7RL3-(V)	NEXTracker 1P	400mm hole distance	±2400
JKMxxxM-7RL3-BDVP			
JKMxxxM-72HL4-TV			
JKMxxxN-72HL4-(V)			
JKMxxxN-72HL4-(V)	PVH MNL+2P MNL2V	Long rail 80x3845x1.5, Hole spacing 1086mm Length fixation 1400mm	+2600/-1600
	PVH AXDUO MNL+1P	Short rail 60x428x1 Hole spacing 1086mm Length fixation 400mm	±1800
		Long rail 60x1128x1.5 Hole spacing 1086mm Length fixation 1100mm	±2400
	NEXTracker 1P	400mm hole distance	±2400
JKMxxxN-78HL4-(V)	NEXTracker 1P	400mm hole distance	±2400
JKMxxxM-72HL4-BDVP JKMxxxN-72HL4-BDV	NEXTracker 1P	400mm hole distance	±2400
	PVH AXDUO MNL+1P	Short rail 60x428x1 Hole spacing 1096mm Length fixation 400mm	±1800
		Long rail 60x1128x1.5 Hole spacing 1096mm Length fixation 1100mm	+2600/-2400

	PVH MNL+2P MNL2V	Long rail 80x3845x1.5 Hole spacing 1096mm Length fixation 1400mm	+2600/-1600
	ATI V3	Hi-rise clamp 300mm	±1200
		Hi-rise clamp 400mm	+1500/-1400
		Through bolt clamp 1300mm bolting at 1100mm position only	±2400
		Through bolt clamp 1400mm bolting at 400mm and 1400mm positions	±3300
JKMxxxN-78HL4-BDV	NEXTracker 1P	400mmhole distance	±2400
	PVH AXDUO MNL+1P	Short rail 60x428x1 Hole spacing 1096mm Length fixation 400mm	±1800
	PVH AXDUO MNL+1P	Long rail 60x1128x1.5 Hole spacing 1096mm Length fixation 1100mm	+2100/-2400
	ATI V3	Hi-rise clamp 300mm	±1200
	ATI V3	Hi-rise clamp 400mm	±1200

**Table 7 Test loads under tracker installation methods for different module types**

### 3. Wiring and Connection

- a) When installing and connecting modules, the foam tube must be removed first, Jinko will not guarantee the safety of products and the consistency of technical parameters if the connecting heads and tools used are not officially specified by Jinko or are not installed according to the official requirements.
- b) PV modules connected in series shall have similar current, (please contact Jinko if there is any concern), and modules must not be connected together to create a voltage higher than the permitted system voltage. The maximum number of modules in series depends on system design and the rating of the inverter used.
- c) The maximum fuse rating value in an array string can be found on product label or product datasheet. The fuse rating value is also corresponding to the maximum reverse current that a module can withstand, for example, when one string is in shade then the other parallel strings of modules will be loaded by the shaded string and the current will pass through to create a current circuit. Based on the maximum series fuse rating of module and local electrical codes and standards, make sure the modules strings in parallel are protected with the appropriate in-line string fuse.

- d) Open the combiner box of the control system and connect the conductor from the PV arrays to the combiner box in accordance with the design and local codes and standards. The cross-sectional area and cable connector capacity must satisfy the maximum short-circuit of the PV system (for a single module, it is recommended that the cross-sectional area of cables be  $4\text{mm}^2$  and the rated current of connectors be more than 10A), otherwise cables and connectors will become overheating for large current. Please pay attention that the temperature limit of cables is  $90^\circ\text{C}$ .
- e) The module frame must be grounded, and the grounding design should be in accordance with local national, regional or international regulations, laws and standards, and the grounding connection should be carried out by qualified electricians.
- f) The grounding device must penetrate the anodic oxide film of the component frame and make full contact with the interior of the aluminum alloy, and the grounding conductor must be connected to earth ground through a suitable grounding electrode.
- g) There are grounding holes with a diameter of 4mm on the long side of the back frame of the module by the edge part, the hole can only be used for grounding, can not be used for the installation of the module, and the frame of the module shall not be punched with additional holes.
- h) Grounding devices and materials shall be provided by qualified manufacturers. Bolts, nuts and washers shall be of a size to match the grounding hole and made of stainless steel, and grounding wires shall be made of copper core wires with a size of AWG 6-12 ( $4\text{-}14\text{mm}^2$ ) and shall comply with the requirements of the relevant local national, regional or international regulations, laws and standards.
- i) JinkoSolar recommends two types of grounding: bolted grounding, shown in Figure 11, and clamp grounding. The bolts should be tightened when grounding is installed and no damage should be done to the module frame or the grounding wire.

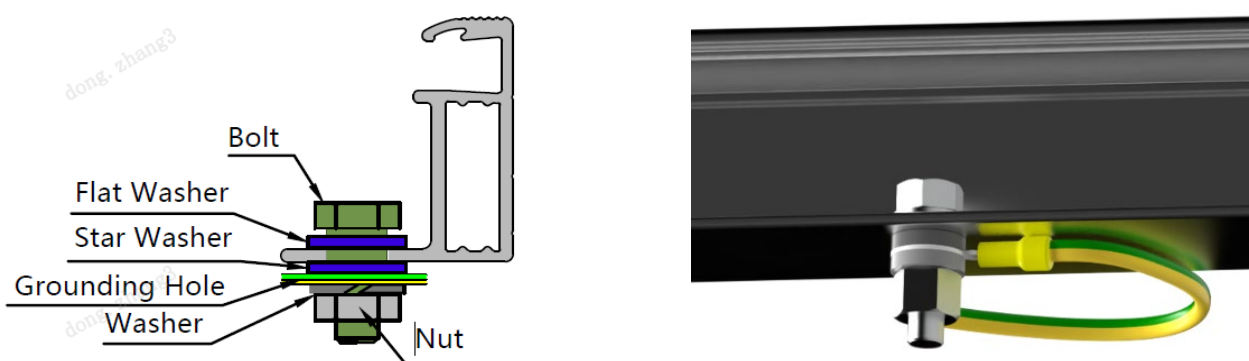

**Fig. 11 Grounding of PV modules**

- j) Follow the requirements of applicable local and national electrical codes.
- k) Modules contain factory-installed bypass diodes. If modules are incorrectly connected to each other, the bypass diodes, cable or junction boxes may be damaged.
- l) The length of the junction box shall be determined according to the component specifications and the customer's design proposal. As shown in Figure 12 below, consider the length of the lead wire

before designing the wiring.

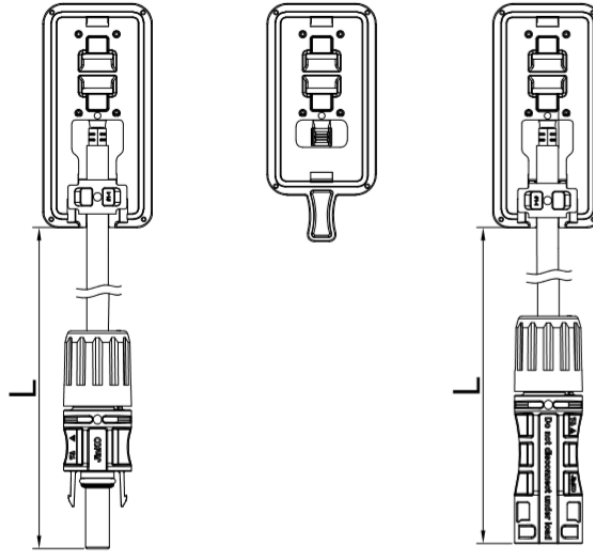

**Fig. 12 The half-cut cell module/ split junction box**

- m) -If modules are connected in series, the total voltage is equal to the sum of individual voltages. The recommended system voltage is as below,  

$$\text{System voltage} \geq N \cdot V_{oc} [1 + TC_{Voc} \cdot (T_{min} - 25)]$$
 -If the modules are connected in parallel, the recommended number of modules in parallel is:  

$$\text{maximum series fuse rating} / I_{sc} + 1$$

Where:

- N module numbers in series
- V<sub>oc</sub> Open circuit voltage (refer to product label or data sheet)
- TC<sub>Voc</sub> Temperature coefficient of open circuit voltage (refer to product label or data sheet)
- T<sub>min</sub> Minimum ambient temperature

- n) For floating projects, please contact local technical support.  
 o) Connectors and bypass diodes from different manufacturers should not be mated together. If such replacement is needed, please contact Jinko Solar.

## 4. Maintenance and Care

It is required to perform regular inspection and maintenance of the modules, especially during the warranty period. To ensure optimum module performance, Jinko recommends the following

maintenance measures:

#### 4.1 Visual Inspection

Inspect the modules visually to find if there are any visual defects, if there are, the following items should be evaluated:

- a) If the modules are observed having slight module color differences at different angles, this is a normal phenomenon for modules with anti-reflection coating technology. If the colors are within the cell, please consult Jinko for further analysis.
- b) Whether the glass is broken.
- c) No sharp objects are in contact with the PV module surfaces.
- d) The PV modules are not shaded by unwanted obstacles or foreign material.
- e) Corrosion along the cells' busbar. The corrosion is caused by moisture intrusion through the module back sheet. Check the back sheet for damage.
- f) Check whether the back sheet is burnt.
- g) Check if screws and mounting accessories are tight, adjust and tighten as necessary.

#### 4.2 Cleaning

- a) A buildup of dust or dirt on the module front face will result in a decreased energy output. Clean the module preferably once per annum, more frequently in dusty conditions, using soft cloth dry or damp. Water with high mineral content may leave deposits on the glass surface and is not recommended. It is recommended to use neutral water of the PH value ranging from 6.5 to 8.5 to clean the glass, so as not to cause damage to the glass coating layer;
- b) Never use abrasive material under any circumstances;
- c) In order to reduce the potential for electrical and thermal shock, Jinko recommends to clean PV modules during early morning or late afternoon hours when solar irradiation is low and the modules are cooler, especially in regions with hot temperatures;
- d) Never attempt to clean PV module with broken glass or other signs of exposed wiring, as this presents a shock hazard;
- e) Never use chemicals when cleaning modules as this may affect the module warranty and energy yield. For the environment with extreme climate, please contact Jinko after-sales department for specific requirement if needed;
- f) For single-side module, backsheet cleaning is not necessary; for dual-glass module, cleaning the module backside regularly when necessary, and follow the requirements in 4.2 a) – e). Please wear insulated gloves and pay special attention to the cables and electrical connections during the backside cleaning.

#### 4.3 Inspection of Connector and Cable

It's recommended to implement the following preventive maintenance every 6 months:

- a) Check the sealing gels of the junction box for any damage.
- b) Examine the modules for signs of deterioration. Check all wiring for possible rodent damage, weathering and that all connections are tight and corrosion free. Check the electrical grounding.

**For more details, please refer to O&M manual**

## 5. Electrical Specification

The electrical properties of the components were measured under standard test condition. In some cases, the component may produce a voltage or current value higher or lower than the rated value. For specific electrical performance parameters, refer to the datasheet in the QR code below.

(Note: the tolerance for Voc is  $\pm 3\%$ , for Isc is  $\pm 4\%$  and for Pmp is  $\pm 3\%$ )



## 6. Disclaimer of Liability

Because the use of the manual and the conditions or methods of installation, operation, use and maintenance of photovoltaic (PV) product are beyond Jinko's control, Jinko does not accept responsibility and expressly disclaims liability for loss, damage, or expense arising out of or in any way connected with such installation, operation, use or maintenance.

No responsibility is assumed by Jinko for any infringement of patents or other rights of third parties, which may result from use of the PV product. NO license is granted by implication or otherwise under any patent or patent rights.

The information in this manual is based on Jinko's knowledge and experience and is believed to be reliable, but such information including product specification (without limitations) and suggestions do not constitute a warranty, expresses or implied. Jinko reserves the right to change the manual, the PV produce, the specifications, or product information sheets without prior notice.

**Global Sales & Marketing Center**

No.1, Lane1466, Shenchang Road,  
Minhang District, Shanghai, China  
Postcode: 201106  
Tel: +86 21 5183 8777  
Fax: +86 21 5180 8600

**Jiangxi Manufacture Base**

No.1 Jinko Road, Economic  
Development Zone, Shangrao  
City, Jiangxi Province, China  
Postcode: 334100  
Tel: +86 793 858 8188  
Fax: +86 793 846 1152

**Zhejiang Manufacture Base**

No.58 Yuanxi Road, Haining Yuanhua  
Industrial Park, Zhejiang Province, China  
Postcode: 314416  
Tel: +86 573 8798 5678  
Fax: +86 573 8787 1070

[www.jinkosolar.com](http://www.jinkosolar.com) | **Technic Support:** [technic@jinkosolar.com](mailto:technic@jinkosolar.com) | **After-sales:** [cs@jinkosolar.com](mailto:cs@jinkosolar.com)

**Technical Customer Service Europe:** [cs.eu@jinkosolar.com](mailto:cs.eu@jinkosolar.com)